

COME RAIN — COME SHINE THIS IS ANTENNAE TIME



- MOSLEY of England Antennae**
Mustang. 3 band 3 elements
Elan. 2 band 3 elements
TA-33 Jr. 3 band 3 elements
TA-32 Jr. 3 band 2 elements
TA-31 Jr. 3 band dipole
V-3 Jr. 3 band vertical
A-310. 10 metre 3 elements
A-315. 15 metre 3 elements
Atlas. 4 band vertical
TD-3 Jr. 3 band trap dipole
RD-5. SWL amateur bands
SWL-7. SWL broadcast bands
D-4Bca. Base loading coil for ATLAS for 80 metres
TW-3X Jr. 20, 40 and 80 metre vertical
VTD-3 Jr. 3 band vertical for difficult locations
MOSLEY U.S.A. types in stock :
MCQ-3B. 10, 15 and 20 metre Quad
MCQ-20. 20 metre Quad
Classic-33. 10, 15 and 20 metre 3 elements
Classic-203. 20 metre 3 elements
A-92-S. 2 metre 9 elements
D1-2. 2 metre. Ground plane
 Other U.S.A. types to special order.



MUSTANG

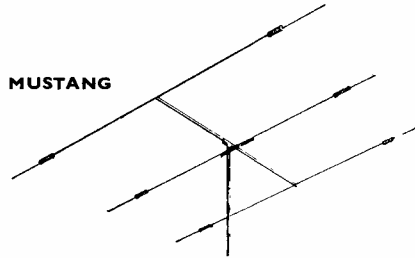

V-3 Jr.

WE ARE THE ANTENNA PEOPLE
 ROTATORS, TOWERS, CABLES, INSULATORS, ETC.

FOR ALL ANTENNA DETAILS:
 Send for complete Handbook, containing full details and prices of Antennas and other technical information. 25 pages, 15p

Refundable upon purchase of an Antenna.

Administrative Address only

Mosley Electronics Ltd. 40, Valley Road, New Costessey, Norwich, Norfolk Nor. 26K



ITEMS COMPONENTS
 BITS & PIECES PARTS
 EQUIPMENT GADGETS

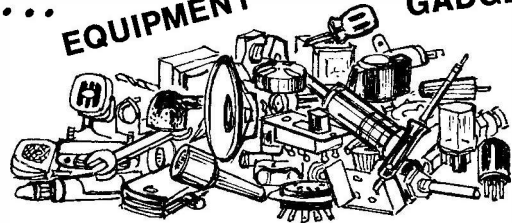

... the best place to get them is **HOME RADIO (COMPONENTS) LIMITED**

Phone: 01-648 8422

Until you've tried the service provided by Home Radio (Components) Limited you've no idea how simple it can be tracking down and obtaining components. It becomes a pleasure instead of a bind! But first you need the Home Radio Catalogue, listing over 8,000 components, over 1,500 of them illustrated. At 70 pence, including p. & p., it's a gift—especially as every copy contains 10 vouchers each worth 5 pence. Send coupon today.

POST THIS COUPON with your cheque or postal order for 70p



Please write in block capitals



Name _____

Address _____

The price of 70p applies only to catalogues purchased by customers in the UK and to BFPO addresses.

HOME RADIO (COMPONENTS) LTD., Dept. SW,
 234-240 London Road, Mitcham, Surrey CR4 3HD.



OUR AESU MUSEN DISTRIBUTOR

When you buy YAESU from their U.K. main distributor you get the best engineering standards in the world and superb performance too. All items carry the YAESU 12 months guarantee. We also do free labour on warranty claims, and carry an excellent stock of spares.

WESTERN

THE SUPERB FT101 (Ex Stock)

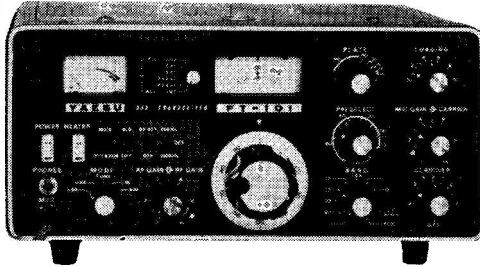

160m. conversion is the Yaesu recommended installation not the version in the February Comms. article.

MATCHING FL2100 LINEAR AMP



FOR BASESTATION OR MOBILE. This easy-to-service (with solid state plus-in modules) comes complete with built-in AC & DC PSU's, speaker and microphone. There is no better value let alone quality! Size 13½" x 6" x 11½"; Wt. 30lb.

160m. model available to Yaesu recommended design.
SPECIFICATION: i/p 260w. p.e.p. SSB, 180w. CW, 80w. AM. Sensitivity 0.3 microvolt for 10dB S/S+N; selectivity 2.4 kHz (6dB down) 4.2 kHz (60dB down). CW filter (extra) 0.6 kHz (6dB down), 1.2 kHz (60dB). Freq. range 3.5-4.0, 7.0-7.5, 14.0-14.5, 21-21.5, 27-27.5, 28-30, 10-10.5 (w/wv), plus 2 spare band positions (1 used for 160m.). Freq. stability less than 100Hz/½ hr. Antenna Z 50-100Ω, swr < 2:1, audio o/p. 3w. 350-2200Hz. 4Ω. Noise-blanker, 25100 kHz calibrator. VOX/PTT. Clarifier ± 5 kHz. 1 kHz readout. Provision for 2 crystal controlled positions and external VFO, linear, panoramic adaptor, transverter, frequency counter.

ACCESSORIES. External VFO FV101, speaker SP101, Fan, CW filter, 160m. Mobile mounting bracket.

NEW MATCHING LINEAR FL2100 (for FT101)

This is another superb piece of YAESU quality engineering with features not found on similarly priced units.

SPECIFICATION: Band coverage 80, 40, 20, 15 and 10m. Driving power 30-100w. p.e.p. Max power i/p. 1200w. p.e.p. 1000w. CV. Distortion products 30dB down or more at 1200w. p.e.p. Size: 13½" x 6" x 11½"; Wt. 41 lb. The FL2100 includes dual cooling fans (one for each tube), dual interlocks low/high voltage. Circuit design features individual tuned input coils on each band for maximum efficiency and low distortion; this is a fully screened compartment. Final amplifier is a pair of rugged Cetron 572B carbon plate tubes. Efficiency has been the keyword in the design of the FL2100 and features low loss ribbon connections to the PI network. 9LC system provides linear operation and changeover circuit automatically biases the tubes to cut-off during receive for cooler operation. SWR bridge built-in which works when the linear is "off".

YD844

FV200 (Ex Stock)

FT200 (Ex Stock)

FP200 (Ex Stock)

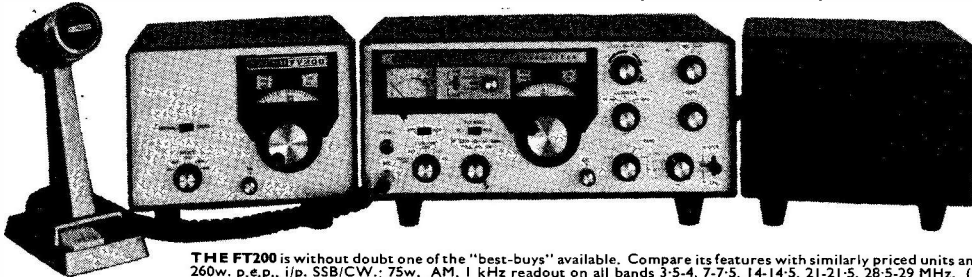

★ WE GUARANTEE ALL ITEMS MARKED EX STOCK ARE AVAILABLE FOR IMMEDIATE DELIVERY

THE FT200 is without doubt one of the "best-buys" available. Compare its features with similarly priced units and kits. **SPECIFICATION:** 260w. p.e.p. i/p. SSB/CW: 75w. AM. 1 kHz readout on all bands 3.5-4, 7-7.5, 14-14.5, 21-21.5, 28.5-29 MHz. (3 optional crystals available for 28-28.5, 29-29.5 and 29.5-30 MHz. Stability: 100Hz 30 mins. after warm-up. Sensitivity: 0.5µV 10dB S/S+N. Selectivity: 2.3 kHz (6dB), 4kHz (60dB). Solid state FET VFO with excellent linearity (like all YAESU VFO's). 25100 Calibrator. VOX/PTT. Separate DC supply available for mobile use. Clarifier ± 5 kHz. Break-in CW keying.

YD844

SP400 (Ex Stock)

FT401 (Ex Stock)

FV401 (Ex Stock)

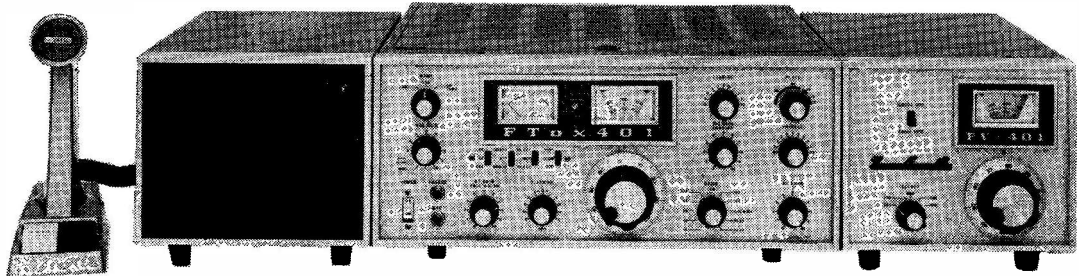

THE FT401 offers a high power SSB/CW transceiver with many extra features at a minimum price.

SPECIFICATION: Power i/p 360w. p.e.p. Built-in CW filter, noiseblanker and blower cooled pa. Complete coverage 80-10m. Plus WWV (10 MHz) to check the 25100 kHz calibrator plus 3 spare band positions. VOX is built-in (not an extra). Dial readout to 1 kHz on all bands. Sensitivity 0.5µV for 20 dB S/S+N. Selectivity: 2.3 kHz (6dB), 3.7 kHz (60dB). CW filter 600 Hz. Clarifier 5 kHz. Break-in CW with sidetone. Selectable USB/LSB.

USED EQUIPMENT (3 months guarantee, carr. £1). KW Vespa, excellent, £80, KW Viceroy, Mk. IV, v.good, £85, KW 2000, v.good, £130, KW 2000A, v.good £160. KW2000B, excellent, £180. Digital 500, new demo model, £250. Hammarlund SP600v, v.good, £85. Trio TS500, un-marked, £125. Swan Cygnet 270, £170. Eddystone EA12, 6 months old, £150. Hallicrafters HT46, as new, £95. Heathkit SB101 and PSU, £140. Sommerkamp FL200B, £80.

ELECTRONICS (UK) LTD



FLDX400 (Ex Stock)

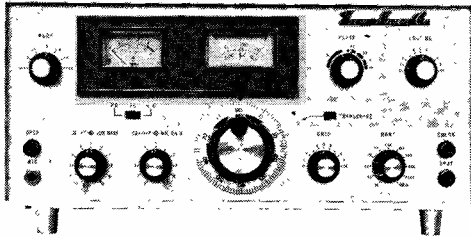

The **FLDX400** Transmitter runs 240w. p.e.p. and is designed to transceive with FR100B or FR400. AM and "break-in" CW keying are fitted. SPECIFICATION: Frequency coverage 3.5-4.1, 6.9-7.5, 13.9-14.5, 20.9-21.5, 27.9-28.5, 28.5-29.1, 28.9-29.5 MHz. Selectable USB or LSB. Stability: less than 100Hz/4hr. after warm-up. Sideband suppression 50dB. Carrier suppression better than 50dB. Netting facilities for zero-testing will receive if not switched to "transceive". Provision for listening on transmit frequency as well as the frequency to which the receiver is tuned. ALC fitted to secure effective performance and a "clean" signal. VOX/PTT operation. Relays operate linear amplifier and receiver. Dial read-out to 1 kHz.

FRDX 400 (Ex Stock)

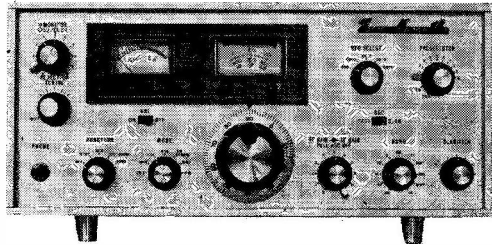

★
NEW
FR400SDX
fitted 4m
+ 160-2m!
(Ex Stock)

The **FR400SDX** (Super de luxe) receiver is now available fitted with 4m. This model is only available from us and covers 160, 80, 40, 20, 15, 11, 10, 4 and 2m. 4 mechanical filters are fitted for SSB (2.4 kHz), AM (5 kHz), CW (0.6 kHz) and FM 24 kHz. Dial readout to 1 kHz from stable VFO. Rejection tuning to notch-out unwanted heterodynes. Clarifier control permits adjustment of SSB/CW received signals when working transceive. VFO select for internal VFO or 4 crystal frequencies. Monitor facility enables transmitted signal to be monitored at all times. Squelch circuitry silences receiver for noise free AM/FM reception. FM discriminator fitted to SDX model, 25/100 kHz calibrator. WVVV band to check calibrated. 3 step AGC. Built-in noise limiter. Basic FR400 receiver from £120.

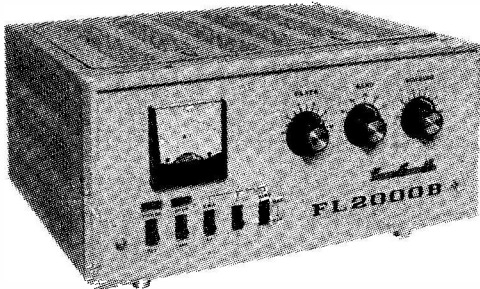

FL2000B
(Ex Stock)

The **FL2000B** operates at a maximum i/p of 1200w. p.e.p. on SSB and covers 80-10m. All grid i/p circuitry is screened. Two cooling fans fitted, one for each rugged 572B carbon anode tube. Built-in SWR bridge functions when linear is "off" or "on"! Safety interlock on lid switches AC supply off. Safety interlock on PA compartment lid bleeds residual HT to earth thus preventing shock from the storage capacitors. All in all the FL2000B is quite a linear!

YC305 FREQ. COUNTER (Ex Stock)

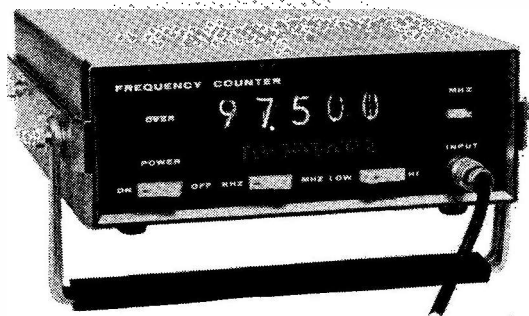

This compact digital frequency counter which is equally suitable for laboratory, industrial or amateur applications has the following specifications: Compact design by advanced IC technique to count wide frequency range 5Hz-30 MHz. Dual range system provides 8 digit measurement with MHz and kHz indicators. 240v. AC/12DC dual power pack built-in; accuracy ± time base stability + 1 count, gate time 1 m.s. or 1 second; input Z 1MΩ, low 56Ω; input capacity = less 20pF; max. i/p 60 v.p.p. less than 10 sec. 20v. p.p. continuous; time base frequency 1000 kHz crystal controlled; stability 0.0005 per cent at 25°C, 0.0025 at 40°C. Dimensions 8 1/2" x 3 1/2" x 10 1/2". Weight 8 lbs.

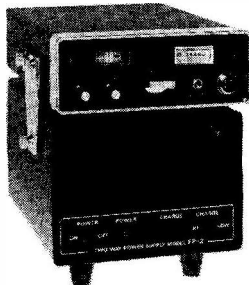

The **FT-2F** opens the door to noise-free broadcast quality two metre FM operation. It is a highly advanced all solid-state unit complete with an automatic toneburst signal. Channel capability of 12 simplex or duplex frequencies. Three channel frequencies included. Advanced cct design protects automatically from damage of transistors caused by antenna trouble or reverse connection power supply. Portable or home base operation can be achieved with the addition of the optional FP-2AC/B power pack which provides regulated DC power for the transceiver and charging voltage for the leak proof re-chargeable colloidal type batteries. Spec. frequency 144-148 MHz., 12 channels. Frequency modulated, power drain, R_x 0.5A T_x 2A., Dimensions 6 1/2" x 2 1/2" x 10". Weight 4lb. Standard accessories, Dynamic mic., and mobile mount. Transmitter RF power 10 or 1w. o/p. Stability < ± 0.001 per cent.

YAESU PRICE LIST

FREE DELIVERY NORMALLY 24 HOURS

12 MONTHS GUARANTEE

| | |
|----------------------------|---------|
| FT101 fitted 160m | £255.00 |
| FT101 transceiver | £240.00 |
| FL2100 Linear Amplifier | £135.00 |
| SP101 Speaker for FT101 | £10.00 |
| FP200 AC supply for FT200 | £38.00 |
| FV200 Remote VFO for FT200 | £38.00 |
| FR400S DX Receiver | £160.00 |
| FL400 Transmitter | £140.00 |
| FT401 Transceiver | £215.00 |
| SP401 Speaker | £10.00 |

| | |
|--------------------------|--------|
| FP2AC AC PSU for FT2F | £25.00 |
| YC-305 Frequency counter | £97.50 |
| YD846 Hand microphone | £5.00 |
| Fan FT101 | £8.00 |
| Mobile mount FT200 | £4.20 |
| CW filter FR400 | £12.50 |
| AM filter FR400 | £7.50 |
| FC2 2m converter | £12.00 |
| FM Unit FR400 | £7.50 |

| | |
|--------------------------|---------|
| FT560 | £195.00 |
| FV101 Remote VFO | £38.00 |
| FT200 Transceiver | £134.00 |
| DC200 PSU for FT200 | £45.00 |
| FR400DX receiver | £120.00 |
| SP400 speaker | £10.00 |
| FL2000B Linear amplifier | £135.00 |
| FL2500 Linear amplifier | £118.00 |
| FV401 Remote VFO | £38.00 |

| | |
|----------------------------------|--------|
| FT2F 2m transceiver | £84.00 |
| FP2AC/B AC supply with batteries | £34.00 |
| YD844 table microphone | £12.00 |
| FP50DX Low pass filter | £6.60 |
| Mobile mount FT101 | £5.00 |
| CW filter FT101, FT401, FT560 | £15.00 |
| Crystals | £2.00 |
| FM filter FR400 | £7.50 |
| FC6 6m converter | £12.00 |

Send S.A.E. for further details and specifications or 15p for post paid spec. prices and 50-page catalogue including all antennas and masts. The best HP terms available only 10 per cent deposit: Part Exchange. Hours of business, Monday to Friday 9 a.m.-5.30 p.m. Saturday 9 a.m.-12.30 p.m.

OSBORNE ROAD, TOTTON, SOUTHAMPTON, SO4 4DN, ENGLAND.
TEL.: TOTTON 4930 and 2785. CABLES: 'AERIAL' SOUTHAMPTON.

STEPHENS - JAMES LTD.

70 PRIORY ROAD, LIVERPOOL, L4 2RZ

Tel: 051-263 7829

G3LRB
G3MCN

The Widest Range of
Equipment in the North

| | | |
|-----------------------------|-----------|--|
| Yaesu-Musen | | |
| FT101 Transceiver | £240 | |
| FT2F 2m Transceiver | £84 | |
| FT200 Transceiver | £172 | |
| FL500 Transmitter | £140 | |
| FR500 Receiver | £120/£160 | |
| Remote VFO's | £38 | |
| FL2000 Loudspeaker | £10.00 | |
| FL2000B Linear | £135 | |
| YDB44 Table Microphone | £12 | |
| YDB46 Hand Microphone | £5.00 | |
| FT401 Transceiver | £215 | |
| KW Electronics | | |
| KW202 Receiver | £140 | |
| KW204 Transmitter | £145 | |
| KW2000B Transceiver | £249 | |
| KW2000B Remote VFO | £39.00 | |
| KW Atlanta Transceiver | £210 | |
| KW Atlanta VFO | £37.00 | |
| KW107 Antenna Matching Unit | £40.00 | |
| KW E-Z Match | £15.00 | |
| KW103 SWR/Power Meter | £12.50 | |
| KW Trap Dipole | £12.50 | |
| KW Traps per pair | £4.50 | |
| KW Dummy Load 50 ohms | £7.00 | |
| KW Balun | £1.95 | |
| KW105 Matching Unit | £37.00 | |
| Trio | | |
| JR599 Receiver | £199 | |
| 9R59DS Receiver | £37.50 | |
| JR310 Receiver | £83.50 | |
| SP5D Loudspeaker | £4.50 | |
| Eddystone | | |
| EC10 Mk. 2 Receiver | £79.00 | |
| A.C. Power Unit | £7.75 | |
| 898 S. M. Drive | £8.92 | |
| EB37 Receiver | £98.00 | |
| Asahi Antenna Range | | |
| 3 Band 3 Element Beam | £60.00 | |
| 40 to 10m. Trapped Vertical | £16.00 | |

| | |
|--------------------------|--------|
| Microphones | |
| Shure 210 | £5.75 |
| Shure 444 | £14.00 |
| Leson TV205A | £7.95 |
| Sentinel 2m. Converters | £13.75 |
| Sentinel 4m. Converters | £13.75 |
| Sentinel 70cm. Converter | £13.75 |

| | |
|--------------------------|--------|
| Codar | |
| T28 Receiver | £17.50 |
| Codar Receiving Kit | £11.50 |
| A.T.S. A.C. P.s.u. | £11.50 |
| A.T.S. Mk. 2 Transmitter | £22.50 |
| PR40 Preselector | £8.50 |

J Beam
We are now stocking the full range of J Beam antennae, at current prices.

| | |
|--------------------------------|---------|
| Secondhand Equipment | |
| National NCX5 Mk. 2 | £185.00 |
| Lafayette KT320 | £26.00 |
| G.E.C. BR7400 | £60.00 |
| Eddystone EC10 Mk. 2 | £60.00 |
| Sommerkamp FL200 Tx | £75.00 |
| Trio JR500 Rx | £50.00 |
| Trio TS510 with A.C. P.s.u. | £140.00 |
| FL500 Transmitter | £100.00 |
| FR500 Receiver | £110.00 |
| Eddystone 888A Receiver | £65.00 |
| Trio 9R59DS Receiver | £40.00 |
| KW Vespa Mk. 2 and A.C. P.s.u. | £90.00 |
| Lafayette HA350 Receiver | £55.00 |
| KW 2000B Transceiver | £195.00 |
| Eddystone 840C | £50.00 |
| Sommerkamp FL2000 Linear | £100.00 |
| Eddystone "S" Meter, grey | £3.00 |
| Lafayette HA600 Receiver | £37.00 |

| | |
|-------------------------------|--------|
| Copal | |
| Copal 222 24 Hour | £8.65 |
| Copal 31 24 hour | £13.00 |
| Copal 601 24 hour Calendar | £17.00 |
| 24 hour Battery Clock | |
| Large | £22.00 |
| Midland 2 Band Aircraft Radio | £8.35 |
| Jumbo 747 Aircraft Radio | £13.00 |
| Vibroplex Keys | £15.00 |
| Semi Automatic Bug Keys | £4.50 |
| HZP Balun I | £3.00 |
| Wight Balun | £3.25 |
| Wight Traps per pair | £2.50 |
| Dipole T Pieces | 13p |
| Egg Insulators | 3p |
| 300 Ohm Twin Feeder | |
| per yd. | 5p |
| 50 Ohm coaxial cable | |
| per yd. | 12p |
| Tunable RF meters | £4.00 |
| PL259 Plugs | 30p |
| Sockets | 30p |
| Cable reducers | 10p |
| Line connectors | 90p |
| QQVO 3-20A | £1.75 |
| QQVO 3-10 | 75p |

Full range of Eddystone die-cast boxes, Stella cabinets, All panels and chassis, Panel meters, plugs, valves. Full information on all products sent on receipt of LARGE S.A.E. Return mail order service on all stocked items. Orders under 25p respectfully declined.
Carriage/postage extra, all items.
All RSGB Publications stocked at current prices.

HP terms arranged on all orders over £25. Minimum deposit 10% on new equipment, 20% on secondhand.
Part exchanges welcomed. Equipment bought for cash. After Sales Service.
Shop hours 9.30 to 1 p.m. 2.15 to 6 p.m. Half day is Wednesday

R. T. & I. ELECTRONICS LTD.

where equipment is fully overhauled

| | |
|--|-------------------------|
| EDDYSTONE EC10 Mk. 1 | £45.00 (£1.00) |
| HALLICRAFTERS SX 117 | £115.00 (£1.50) |
| HAMMARLUND HQ 170 | £150.00 (£1.50) |
| LAFAYETTE HA-600 | £36.00 (£1.00) |
| LAFAYETTE HE-90 | £48.00 (£1.50) |
| LAFAYETTE HE-30 | £24.00 (£1.25) |
| HEATHKIT MOHICAN | £35.00 (£1.25) |
| NATIONAL NCX-500 Transceiver c/w a.c. p.s.u. | £230.00 (£3.00) |
| HAMMARLUND HQ-145-X | £135.00 (£2.00) |
| RCA AR88 | £70.00 (£2.00) |
| LAFAYETTE HA-63 | £22.00 (£1.00) |
| HAMMARLUND Q180 | £150.00 (£2.00) |
| HEATHKIT GR64 | £25.00 (£1.00) |
| EDDYSTONE 840A | £35.00 (£1.50) |
| KW 201 | £90.00 (£1.50) |
| KW VESPA II c/w p.s.u. | £105.00 (£2.00) |
| KW 77 | £70.00 & £80.00 (£1.50) |
| HALLICRAFTERS S 240 as new | £35.00 (£1.00) |
| EDDYSTONE 940, as new | £135.00 (£1.50) |

WE CAN ALSO SUPPLY ANY MAKE OF NEW EQUIPMENT—and have pleasure in giving a few examples which are normally in stock:—

- ANGLIA**, 2 metre converters (state I.F. required), £15.00 (30p).
- AVOMETERS**, Model 7, Mk. 2, £37.60; Model 8, Mk. 4, £40.90; Model 9, Mk. 4, £40.90; Model 40, Mk. 2, £37.60; Multiminor, Mk. 4, £13.50; Standard leather carrying case (Models 7, 8, 9, 40), £6.50; Every-Ready 6150, £7.40; Multiminor leather case, £3.30; 10K, D.C. Multiplier for Model 8 or 9, £6.10; 30KV D.C. ditto, £9.90; Pair of Long Reach Safety Clips, £1.50; Model EA113 Electronic Avo, £82.00. All above post free in U.K. Trade and Educational enquiries invited.
- S. G. BROWN'S HEADPHONES**, Type "F" 120 ohms, 2,000 ohms, 4,000 ohms, £4.95 (25p); Rubber earpads for same, 45p per pair (5p). Type 3C/1100 Noise excluding (with superb fitting), high quality, electro-dynamic, £7.55 (25p). Standard Jack Plugs, 24p (4p).
- EDDYSTONE EQUIPMENT**, Receivers, 8307, £372.75; EA12, £205.00; EC10/2, £79.00; EC10/1, £64.50; 924 A.C. mains p.s.u., £7.75 (50p); Doublet Aerial, 731/1, £5.28 (50p); Plinth Speaker, 906, £6.20 (50p); General Purpose Speaker, 935, £5.55 (40p); Edometer, 902 Mk. 2, £29.50 (50p); Telescopic Aerial, PL3126, £2.50 (25p); Diecast Boxes from 45p (10p). Brochure on request.
- CODAR EQUIPMENT**, AT5 Mk. II, £22.50 (50p); PR 40, £8.50 (30p); 250/5, £11.00 (65p); CR70A, £22.50 (65p); T28, £17.50 (25p); PR30, £7.50 (25p); PR30X, £9.50 (25p); 12M/A, £11.50 (40p); 12/RC, £2.50 (15p); RQ10X, £9.00 (35p). Leaflets on request.

Our latest list of over 50 receivers, and many other interesting items sent free upon receipt of your s.a.e. Carriage for England, Scotland and Wales shown in brackets. Terms: C.W.O., Approved Monthly Accounts, Hire Purchase and Part Exchange. Special facilities for export. Enquiries invited.

- At R.T. & I.
- ★ We have full H.P. facilities
- ★ Part exchanges are a pleasure
- ★ We purchase for cash
- ★ We offer a first-class overhaul service for your electronic equipment, whether you are an amateur or professional user
- ★ We have EASY Parking facilities
- ★ We welcome your enquiries for specific items which, although not advertised, may very well be in stock.

PARTRIDGE "JOYSTICKS," "New Lightweight VFA" £12.99 (30p), "JOYMATCH" III. Aerial Tuning Unit, £12.99 (30p). Literature on request.

TRO EQUIPMENT, Transceiver, TS-510 + PS-510 a.c. p.s.u., £180.00 (£2.00); VFO-5D for above, £25.00 (50p); Receivers, JR-599, £185.00 (£1.00); JR-310, £77.50 (£1.00); JR-500-SE, £85.00 (£1.00); 9R-59-DS £47.50 (50p); SP-5D Loudspeaker, £4.37 (40p); Headphones, HS-4, £5.97 (20p). **NEW TR-599 TRANSMITTER** (to match JR-599), £185.00 (£2.00). Leaflets available.

SHURE MICROPHONES, 444T, £15.00 (40p); 444, £13.00 (40p); 401A, £6.50 (30p); 201, £5.40 (30p); 202, £6.00 (30p). Full details on request.

KEYNETERS, piano key mains connector units, £2.75 (25p). **VALVES**. Please state your requirements.

TMK METERS: TMK500, £8.25 (25p); TW20CB, £10.25 (25p); TP50SN, £5.75 (25p); 700, £16.50 (25p); also leather cases.

PHILIPS PM2403 ELECTRONIC MULTIMETER, £49 (25p).
We also supply **PHILIPS and KORTING COLOUR TV TEST EQUIPMENT**, including Colour Bar Generators, Convertors, etc.
KW EQUIPMENT, KW2000B + A.C. p.s.u., £240.00 (£2.00); D.C. p.s.u. for KW2000B, £44.00 (50p); KW 2000B only, £200.00 (£1.50); KW ATLANTA + A.C. p.s.u., £200.00 (£2.00); Remote V.F.O. for Atlanta, £34.00 (50p); VOX unit for Atlanta, £7.50 (25p); Remote V.F.O. for 2000B, £36.00 (50p); KW1000 Linear amplifier, £135.00 (£1.50); KW202 Receiver with calibrator, £140.00 (£1.50); KW 202 Matching Spkr., £8.00 (80p); KW204 Transmitter, £142.00 (£2.00); KW105 combined E-Z Match; VSWR indicator, dummy load, and ant. switch (4 outlets) 52 or 75 ohms, £36.00 (50p); KW103, VSWR and power meter, 52 ohms, £12.50 (45p); KW101, VSWR meter, 52 or 75 ohms, £9.25 (30p); KW107, £40.00 (50p); also E-Z match, dummy load, trap dipoles, etc., etc. Details on request.

R. T. & I. ELECTRONICS LTD.

Ashville Old Hall, Ashville Road, London, E.11 Tel: 01-539 4986

NORTH WEST ELECTRICS

769, STOCKPORT ROAD,

LEVENSHULME,

MANCHESTER, 19.

Phone: 061-224 4911

G3MAX

**EDDYSTONE AND TRIO RECEIVERS. DIECAST BOXES.
JACKSON CAPACITORS AND DRIVES. DENCO COILS.
"RADIOSPARES" TRANSFORMERS AND COMPONENTS.
"Q" MAX CUTTERS.**

TRANSISTOR I.F. AMPLIFIER PACK. 470 kHz. Double tuned IFT's with diode output, printed circuit board $6\frac{1}{2}'' \times 2\frac{3}{4}''$. 3 transistors, all resistors and capacitors supplied with circuit and instructions, £3, post 10p. Printed circuit volume control 5K SP Sw. to fit board, 25p.

BARGAIN OFFER. 100 yard drum 75 ohm high power coaxial cable. Attenuation per 100ft. 2.8 dB 200 MHz. 4 dB 600 MHz. 5.3 dB 800 MHz., £6.75, carriage £1.

DENCO COILS. All ranges in stock. 32p each, post 5p each coil. Please state valve or transistor type when ordering.

POT CORE. .666 dia. With bobbin on $\frac{1}{4}''$ Aladdin former. Type 10D, 14p, post 5p.

POLYPROPYLENE ROPE. 500lb. strain. 100 yd. reel, £1, post 15p.

MODULATOR, TYPE 105. Ex-TR 1986 series. 2-6C4 in push pull. EF92 Mic amp. EL91 driver. New, boxed with circuit, 75p, post 25p.

SMALL POWER TRANSFORMERS. Drop through Mtg. $3'' \times 2\frac{1}{2}'' \times 2\frac{1}{2}''$. Above chassis, post 27p each. 240v. 100mA. 6.3v. 2A. LT, £1.25. 180v. 40mA. 6.3v. 2A. LT, 87p. 180v. 25mA. 6.3v. 2A LT, 70p.

COAX LINK LEAD. 8' 6" cable with 2 Burndept/Londex coax plugs, 35p each, post 15p. (50 Ω impedance).

AR88 MAINS ON/OFF C.W. SWITCHES. New Boxed, 32p, post 5p.

VIBRATORS. 12 volt synchronous. Type No. 12SR7, 50p each. Special offer 3 for £1, postage 15p.

CONVERTER CHASSIS. New spares for transistorised UHF tuner. Contains 4 gang min. var. cap. 4 tube trimmers, in screened sections, 25p, post 15p.

JACKSONS 6/36 slow motion dial and drive, £1.55, post 15p.

TRANSFORMER. Specially wound for Digital instruments. 200 volt 40 mA HT. 6 volt 1A. Two windings LT. Will supply 6v. 2A. or 12v. 1A. CT $2\frac{3}{4}'' \times 2'' \times 2\frac{1}{4}''$, £1.50, post 55p.

CV416 (6F17) VALVE, 30p each, post 5p, or 4 for £1.20, post paid.

5" DESYN INDICATOR, 75p, post 25p.

3" DESYN INDICATOR. 62p, post 20p. Compass degrees and corrector on 5" Desyn only.

OUTPUT METER. MARCONI TF340. 5 milliwatts to 5 watts. 2.5 ohm to 20k Input Impedance. Output indicated on 3" 200 uA Meter. Fair condition. Tested before despatch, £5, post 55p.

TUNER UNIT. 2-Roller coils, $1\frac{1}{2}''$ dia. $5\frac{1}{2}''$ long. 3-Miniature D.C. motors. 3-Sangamo relays 200-200 micro amp movements. 6-700 ohm sealed relays. 3-170 ohm sealed relays. 1-500 uA meter, £3.00, post 65p.

IF STRIP. Ex R3673 Rx. 7.5 mH with circuit. Less valves. 8 B7G PTFE holders. Sealed relay twin 500 ohm coil. 12-pin plug and socket, 50p, post 20p.

CONVERTER 20 to 90 MH. 7.5 mH IF. Ex 3673 Rx. 2/EF91's. 1-6J6 Osc., £1.25, post 20p. Some less valves, 75p, post 20p.

300ft. COPPER AERIAL WIRE. Lightweight braided. Brand new, boxed. Dinghy wire, 75p, post 10p.

PRINTED CIRCUIT BOARD. Single sided copper laminate. $6\frac{1}{2}'' \times 4\frac{1}{2}''$. 10 for 20p, post 15p.

SPECTRUM ANALYSER, MARCONI OA1094. Frequency range 0-10 kHz. 200-800 kHz. 3:1 to 30 MHz. Complete on trolley. 1 only, £250.

ALI. MINI BOXES. With fitted lid. Post 5p per box.
 $3'' \times 2'' \times 1''$, 33p $5\frac{1}{2}'' \times 4'' \times 1\frac{1}{2}''$, 43p
 $4'' \times 2\frac{3}{4}'' \times 1\frac{1}{2}''$, 38p $4'' \times 2\frac{1}{2}'' \times 2''$, 38p
 $4'' \times 4'' \times 1\frac{1}{2}''$, 38p $5'' \times 2\frac{3}{4}'' \times 1\frac{1}{2}''$, 38p

INSTRUMENT CONTROL KNOBS. Black with bright Ali. centre, $\frac{1}{8}''$ brass insert with grub screw. 1", $1\frac{1}{4}''$ and $1\frac{1}{2}''$ dia., 15p each, post 5p each. Any excess refunded.

Business Hours: Tues.-Fri., 9.30 a.m. to 6.30 p.m.
 SATURDAY: 9 a.m.-5 p.m. OPEN ALL DAY.
 CLOSED ALL DAY MONDAY.

WE WELCOME ALL ENQUIRIES HOWEVER SMALL
 Stamped addressed envelope please for special offer list.

WE WOULD BE PLEASED TO RECEIVE QSL CARD FOR DISPLAY

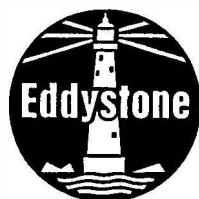

"LISTEN TO THE WORLD WITH EDDYSTONE"

**Your local Eddystone dealer
is:**

CHESHIRE

The Transistor Centre
(Wilmslow) Ltd.
Green Lane
Wilmslow 24766

CORNWALL

R. V. Heming Ltd.
(Peter Heming G3WBW)
Cliff Road, Newquay
Newquay 2191

S.S.B. Products
(Norman Birkett G3EKX)
7 Little Castle Street
Truro
Devoran 862575

DERBYSHIRE

J. & A. Tweedy (Electronic
Supplies) Ltd
64 Lordsmill Street
Chesterfield
Chesterfield 4982

DEVON

Graham Newbery
(Reg. Ward G2BSW) Axminster
Axminster 3163

ESSEX

F. E. Smith
184 Moulsham Street
Chelmsford
Chelmsford 54594

HAMPSHIRE

Southern Marine Radio
(Southampton) Ltd
Solent House, Town Quay
Town Quay 22721

Wireless Supplies Unlimited
264-266 Old Christchurch Road
Bournemouth
Bournemouth 24567

IRELAND

John F. MacMahon
10, Church Street, Enniskillen
Co. Fermanagh, N. Ireland
Enniskillen 2955

ISLE OF WIGHT

Sherratt & Son
81-82-83 High Street, Newport
Newport 3358-9

KENT

G. T. & R. Wilson
12-14-16 Queen Street
Gravesend
Gravesend 63527/8

LANCASHIRE

oldings Photo Audio Centre
incing Lane - Darwen Street,
Blackburn BB2 2AF
Tele. 59595

Stephen-James Ltd
70 Priory Road, Anfield
Liverpool L4 2RZ
051-263 7829

North West Electrics
769 Stockport Road
Levenshulme, Manchester 19
061-224 4911

Croftfilm Ltd
46 Friargate
Preston PR1-2AT
Preston 55244

LEICESTERSHIRE

A. K. Davey Ltd
New Street, Hinckley
Hinckley 2173 and 4288

LONDON

Imhofs (Retail) Ltd
112-116 New Oxford Street
W.C.1
01-636 7878

R. T. & I. Electronics Ltd
Ashville Old Hall
Ashville Road
Leytonstone, E.11
01-539 4986

Radio Shack Ltd
182 Broadhurst Gardens
London, N.W.6
01-624 7174

NORFOLK

The Record Shop
157 King Street
Great Yarmouth

NORTHUMBERL'D

Aitken Bros & Company
35 High Bridge
Newcastle upon Tyne NE1 1EW
Newcastle upon Tyne 26729

SCOTLAND

L. Hardie
542 George Street
Aberdeen
Aberdeen 20113

WALES

Holt High Fidelity
Picton Arcade, Swansea
Swansea 53254

Holt High Fidelity
8 Portland Street, Swansea
Swansea 41032

WARWICKSHIRE

Chas. H. Young Ltd
170/172 Corporation Street
Birmingham 4
021-236 1635

CALL BOOKS

INTERNATIONAL:

| | |
|---|-------|
| RADIO AMATEUR CALL BOOK | |
| "DX Listings" | £3.10 |
| "U.S. Listings" | £4.10 |
| The two together, covering the World | £6.80 |
| "G's" only 1972 | 60p |

MAPS

AMATEUR RADIO MAP OF WORLD

Mercator Projection — Much DX
Information — in colour. Second
Edition 65p

DX ZONE MAP (GREAT CIRCLE)

In colour with Country/Prefix
Supplement Revised to Dec.
1970 85p

RADIO AMATEUR MAP OF THE U.S.A. AND NORTH AMERICA

State boundaries and prefixes, size
24" by 30", paper 60p

RADIO AMATEUR'S WORLD ATLAS

In booklet form, Mercator projec-
tion, for desk use. Gives Zones
and Prefixes 85p

LOG BOOKS

| | |
|---|-----|
| Standard Log (New Glossy Cover) | 55p |
| Log and VHF Contest Log | 40p |
| Receiving Station Log | 45p |
| ARRL. Log (Spiral) | 70p |

(The above prices include postage and packing).
Delivery is from stock.

MORSE COURSES

G3HSC Rhythm Method of Morse Tuition

| | |
|--|-------|
| *Complete Course with three 3 speed L.P. records with books | £4.50 |
| *Beginner's course with two 3 speed L.P. records with book . | £3.30 |
| Single 12" L.P. Beginner's with book | £2.75 |
| Single, 12" L.P. Advanced with book | £2.75 |
| Three speed simulated GPO test. 7" d.s. E.P. record | 85p |
| Ex.Gov. Heavy Duty Morse Keys Fully Shrouded | 95p |

Prices include postage, packing and insurance
in U.K. only *Overseas orders + £1.00.

Available from

SHORT WAVE MAGAZINE

Publications Dept., 55 Victoria Street,
London, SW1H 0HF 01-222 5341

(Counter Service, 9.30-5.15, Mon. to Fri.)

(Nearest Station: St. James's Park)

(GIRO A/C No. 547 6151)

How to measure very high frequencies at very low cost:

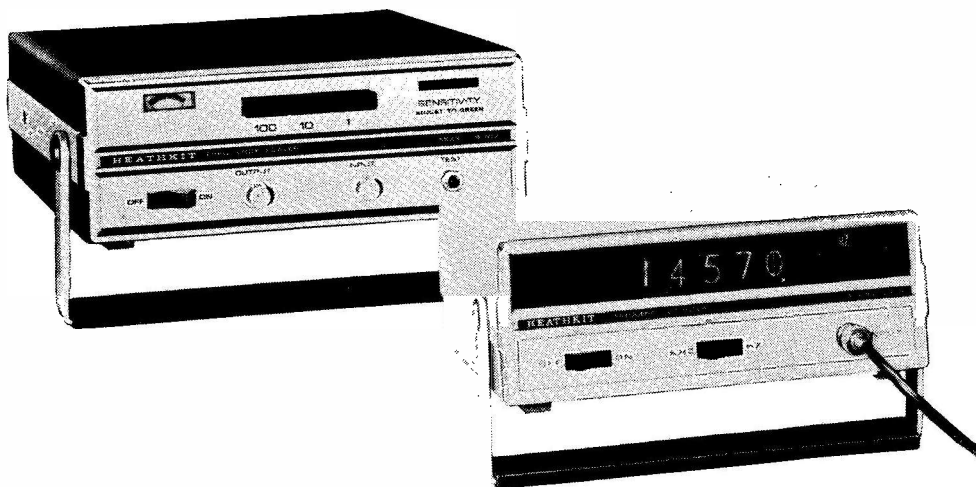

Combine the new Heathkit IB-102 Scaler and IB-101 Counter and get 75 MHz capability for less than **£150!**

The Heathkit IB-101 : 15 MHz for just **£95**. An accurate, low cost counter for dozens of applications. Delivers instant, reliable counting from 1 Hz to over 15 MHz with 5-digit cold-cathode readout tubes. Computer-type integrated circuitry eliminates blinking readout . . . provides a rock-stable divider chain that never needs adjustment. Hz/kHz switch and overrange indicator give the IB-101's 5-digit readout the same capability as an 8-digit counter. Set the range switch to kHz and read out to the nearest kHz . . . push the switch to the Hz position and read down to the last Hz. Overage and Hz/kHz indicators light up to give correct range and error-free measurement . . . make an 8-digit measurement to over 15 MHz in seconds. The exclusive Heath-designed dual gate, diode-protected MOSFET input circuit provides proper triggering over a wide range of input levels . . . without adjustment or input attenuators. Input Z is 1 megohm shunted by less than 20 pF to minimize loading. A special low drift, temperature compensated 1 MHz crystal oscillator provides a highly stable time base. Other features include all solid-state circuitry using 26 ICs, 8 transistors and 6 diodes . . . combination carrying handle/tilt stand . . . BNC input with cable supplied . . . easy 6 hour assembly. Shipping weight : 7 lbs.

Extend the range of virtually any frequency counter to 175 MHz for only **£40***. The new Heathkit IB-102, in combination with the IB-101 or virtually any other existing counter, gives you fast, accurate, reliable measurement capability into the VHF region for less than **£150**. The IB-102 will divide input frequencies from 2 MHz to 175 MHz with the scaled output fed to any compatible counter with a 1 megohm input. Front panel switch-selection of 10 : 1 or 100 : 1 scaling ratios . . . resolution down to 10 Hz with a counter

having 1 second time base. For use with frequencies within the range of the counter being used, a 1 : 1 switch position provides straight-through counting without scaling. The exclusive Heath input circuit triggers at extremely low signal levels, increasing versatility greatly. At 100 MHz, for example, only 50 mV maximum is needed to trigger. The front panel Test switch gives a quick, easy method of checking input level. Other features include all solid-state IC/transistor design . . . handy tilt stand-carrying handle and easy 5 hour design. Get into VHF measurement the easy, inexpensive Heath way . . . with the new IB-102. Shipping weight : 7 lbs.

- Please send Specification Sheets
- Please send FREE Heathkit Catalogue.

Name

Address

Prices and specifications subject to change without notice.
*Mail order prices ; ex factory. SWM 03/72

KIT MODEL IB-101 £95.00 plus 40p post. KIT MODEL IB-102 £40.00 plus 40p post.

Please address all enquiries & correspondence:

HEATH (Gloucester) LTD. GLOUCESTER
GL2 . 6EE TEL. 29451



A Schlumberger Company

Radio Shack Ltd★ **London's Amateur Radio Stockists**

Just around the corner from West Hampstead Underground Station

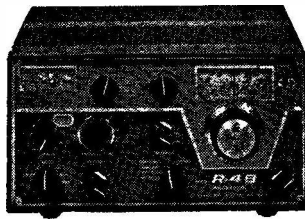
R. L. Drake's Magnificent 4B**T-4XB Transmitter and R-4B Receiver****T-4XB £219.50**
AC-4 p.s.u. £46.95**R-4B £122.50****MS-4 £9.95**

All the rest of the Drake equipment including the TR-4 transceiver.
Entire range of Hy-Gain Antennas amongst the rest of the gear at

RADIO SHACK LTD.**182 BROADHURST GARDENS, LONDON, N.W.6.**

Just around the corner from West Hampstead Underground Station

Telephone: 01-624 7174 Cables: Radio Shack, London, NW6-3AY.

Giro Account No.: 588 7151

AMATEUR ELECTRONICS**BIRMINGHAM 021-327 1497 021-327 6313**

Please note that we are still fully operative from our usual address as our move to larger premises has been temporarily delayed and for at least six weeks from the date of this advertisement we shall be operating from 518/520 Alum Rock Road. We shall, therefore, continue to give our normal service to all postal and telephone orders/enquiries and even after the change-over, with luck, our telephone numbers should remain unchanged.

At the time of going to press we URGENTLY REQUIRE all classes of Communications equipment, including gear of the most sophisticated type and are particularly anxious to purchase Collins equipment. We do, of course, pay spot cash, are able to settle existing hire purchase accounts and for those readers in the general London area our Southern agents can very often arrange collection.

This month we list several interesting items of second-hand equipment, together with details of accessories stocked, concerning which we get many postal enquiries.

| | | | |
|--|--------|---|---------|
| HEATH SB-301 and SB401 SEPARATES. In absolutely mint condition ... | £ | EDDYSTONE 740 RECEIVER. Good all round condition ... | £ |
| HEATH HW17 2 METRE TRANSCEIVER. Excellent condition ... | 262.50 | TRIO 9R59DE RECEIVER. Unmarked and perfect in all respects ... | 25.00 |
| SOMMERKAMP FT200 TRANSCEIVER with FP200 and DC200 A.C. and D.C. P.s.u.'s. Absolutely mint condition ... | 61.00 | HEATHKIT GR78 GENERAL COVERAGE RECEIVER. A complete brand new kit for assembly of this latest solid state Receiver. Absolutely mint, ex Messrs. Heathkit and complete with guarantee. | 38.50 |
| LAFAYETTE HA350 RECEIVER. Excellent in all respects... | 175.00 | KW VICEROY Mk. III TRANSMITTER. Excellent condition | 67.50 |
| HAMMARLUND SP-600X RECEIVER. Yet another excellent specimen just to hand | 67.50 | TRIO 9R59DS RECEIVERS. We regret that future stocks of these will be at the new price of £57.50 plus carriage but are pleased to announce that at the time of going to press we have a good stock at the old price of ... | 47.50 |
| EDDYSTONE 940 RECEIVERS. Choice of two, both mint condition ... | 97.50 | COPAL DIGITAL CLOCKS. Owing to a bulk purchase we are now able to offer these at the most competitive price as yet on the British market. | |
| ... Late model | 115.00 | Model 222 ... post paid | 8.00 |
| ... Early model | 105.00 | Model 101 ... post paid | 10.75 |
| R.S.W. ELECTRONICS 2 METRE TRANSMITTER. 90 watts input. An excellent commercial rig with inbuilt modulator and p.s.u. ... | 60.00 | Model 401 ... post paid | 13.25 |
| EDDYSTONE EC10 Mark I RECEIVER, late model, mint condition ... | 49.00 | OSKER BLOCK POWER METER. A precision individually calibrated watt meter come S.W.R. bridge. Frequency range 3.5 MHz—1.50 MHz with a power capacity ranging from 2 watts to 2 Kw. Beautiful construction and appearance ... | 18.00 |
| EDDYSTONE EC10 Mark II RECEIVER, late model, excellent condition | 47.00 | MEDCO LOW PASS FILTERS. FL50B and FL75B, UHF connectors ... | |
| EDDYSTONE EC10 Mark II RECEIVER, complete with mains p.s.u. | 70.50 | FL50A and FL75A, Belling connectors ... | 6.00 |
| EDDYSTONE EA12 RECEIVER, late model, excellent condition | 140.00 | FH40 HIGH PASS Filter ... | 2.10 |
| EDDYSTONE EA12 RECEIVER, late model, truly mint condition | 150.00 | PL259 UHF CONNECTORS 30p ea. Right-angled plugs ... | 65p ea. |
| HEATH MOHICAN RECEIVER, slight superficial marks, complete with mains p.s.u. | 37.50 | ADAPTORS. Size 1 ... 10p ea. SO239 sockets ... | 28p ea. |
| HEATH MOHICAN RECEIVER, mint condition, less p.s.u. | 37.50 | ADAPTORS Size 2 ... 10p ea. Straight adaptors ... | 45p ea. |
| EDDYSTONE 840C RECEIVERS. Further sets now in stock. | | SHURE MICROPHONES M.201 PTT Hand Model ... | 5.75 |
| Grade "A" Mint condition ... | 50.50 | 444 Desk Model ... | 14.00 |
| Grade "B" Very good condition ... | 48.50 | | |
| Grade "C" Very slight superficial marks ... | 46.60 | | |

PLEASE NOTE ALL PRICES IN THIS ADVERTISEMENT INCLUDE POSTAGE OR CARRIAGE.

ARRBD RECEIVERS REQUIRED. Any quantity—please state price and condition.

Southern Agents —J. H. Associates Limited, Cricketfield Lane, Bishop's Stortford, Herts. Tel. 0279 56347 Telex: 81553

ELECTRON HOUSE, 518-520 ALUM ROCK ROAD, BIRMINGHAM 8

LOWE ELECTRONICS

119 CAVENDISH ROAD, MATLOCK, DERBYSHIRE, DE4 3HE

Tel. Matlock 2817 or 2430 9 a.m. - 9 p.m.

BILL G3UBO ALAN G3MME

Service & Sales
(evenings & weekends only)

John G3JYG 16 Harvard Road, Ringmer, Lewes, Sussex.
Ringmer 812071

Sim GM3SAN 19 Ellismuir Road, Baillieston, Nr. Glasgow.
041-771 0364

Main YAESU MUSEN CO. LTD. Distributors

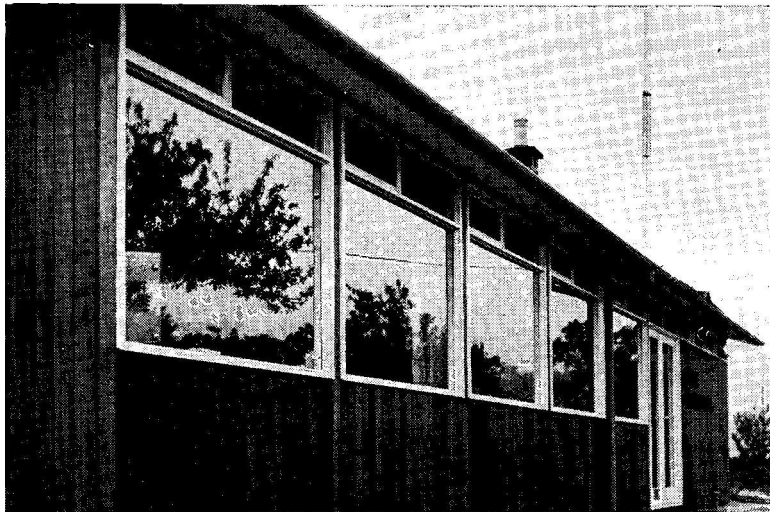

We have a great QTH—come along and try any piece of Yaesu gear on the air with either our Asahi 3-element beam, our Asahi vertical, our Diamond vertical or an 80m dipole, not forgetting the 2m beam for FT-2F's, etc. **They are all in stock.**

It pays you hands down to deal with an **Authorised Yaesu Musen Distributor** who has the facilities, ability and stock of spares to service your gear should it ever require it.

New Licenses—come along and see our wide range of new and second-hand gear. Try it thoroughly before buying. **Service.** We know (and I'm sure you do) that Yaesu equipment is unquestionably the best buy. Of this there is no doubt, but what we would emphasise is that top-class equipment requires a top-class service department. We've got one.

Second-hand. We have an excellent selection of better-class equipment all thoroughly checked and serviced. Reading the magazines, our second-hand prices seem to be just that bit lower than average. Write for lists. If you have good quality gear to sell—we'll buy it.

2m F.M. IC-20, FT-2F and IC-2F owners. Come along and check your gear using our test gear. Check your output on a proper wattmeter, check your deviation on a Marconi deviation meter, check your mobile antenna S.W.R. with a Bird ThruLine. And so on.

Special. Linears for peanuts. We have a few FE-3500 linears left. These are brand new 1500W p.e.p. linears, built-in S.W.R. meter, electronically regulated screen voltage. Extremely well built at a give-away price, £65.

Send us a **large** s.a.e. and we'll fill it with details of receivers, transmitters, transceivers, station accessories, antennas, etc.

Service (evenings and weekends) :

Dave Dryden, G3BKQ
Alan Bartlett, GW3YSA
Peter Ward, G3XWX

205 Main Street, Thornton, Leics.
35 Pen-Y-Waun, Efail Isaf, Nr. Pontypridd, Glam.
47 Radstock Avenue, Ward End, Birmingham, B36 8HD
73 de Alan and Bill

Hours : Tuesday to Saturday 9 to 5.30 (closed for lunch 1 to 2 and all day Monday)

25p

The
SHORT WAVE
Magazine

VOL. XXX

MARCH, 1972

NUMBER 1



WORLD WIDE COMMUNICATION

MULTI-METERS



MODEL 500 30,000 O.P.V. with overload protection mirror scale 0/5/2.5/10/25/100/250/500/1,000v. D.C. 0/2.5/10/100/250/500/1,000v. A.C. 0/50µA/5/50/500mA. 12 amp. D.C. 0/60/120 Meg. Ω, £8-87½ Post paid.



TMK MODEL TW-50K 46 ranges, mirror scale. 50K/Vol. D.C. 5K/Volt A.C. D.C.: Volts -125, -25, 1-25, 2.5, 5, 10, 25, 50, 125, 250, 500, 1000v. A.C. Volts -1.5, 3, 5, 10, 25, 50, 125, 250, 500, 1000v. D.C. Current: 25, 50µA, 2.5, 5, 25, 50, 250, 500mA, 5, 10 amp. Resistance: 10K, 100K, 1 Meg, 10 Meg Ω. Decibels: -20 to +81.5 dB, £8-50. P. & P. 17½p



MODEL 5025 57 Ranges. Giant 5 1/2 in. Meter. Polarity Reverse Switch. Sensitivity: 50K/Volt D.C. 5K/Volt A.C. D.C. Volts: -125, -25, 1-25, 2.5, 5, 10, 25, 50, 125, 250, 500, 1000v. A.C. Volts: 1.5, 3, 5, 10, 25, 50, 100, 1,000v. D.C. Current: 25, 50µA, 50LA, 2.5, 5, 25, 50, 250, 500mA, 5, 10 amp. Resistance: 2K, 10K, 100K, 1Meg, 10 Meg. Decibels: -20 to +85 dB, £12-50. P. & P. 17½p.



MODEL S-100TR Multi-meter/Transistor Tester 100,000 O.P.V. Mirror Scale/Overload Protection. 0/12/6/13/2/30/120/600v. D.C. 0/6/120/600v. A.C. 0/12/600µA/12/100 Meg -20 to +50 dB. 0.01-2 MFD. Transistor tester measures Alpha, Beta and Ico. Complete with batteries, instructions and leads, £13-50. P. & P. 25p.

POWER SUPPLY UNITS

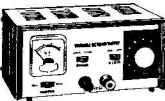

RP214 Regulated Power Supply. Solid state. Variable output 0-24v.D.C. up to 1 amp. Dual scale meter to monitor voltage and current. Input 220/240v. A.C. Size: 185 x 85 x 105mm., £8-97. P. & P. 25p.

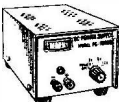

PS.1000B Regulated Power Supply. Solid state. Output 6, 9 or 12 volt D.C. up to 3 amps. Meter to monitor current. Input 220/240v. A.C. Size: 4" x 3 1/2" x 6 1/2", £11-97. P. & P. 25p.

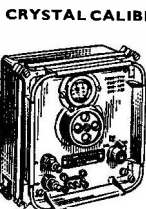

CRYSTAL CALIBRATOR No. 10 Small portable crystal controlled wave meter. Size 7" x 7 1/2" x 4". Frequency range 500 Kc/s.-10 Mc/s. (up to 30 Mc/s. on harmonics). Calibrated dial. Power requirements 300v. D.C. 15mA and 12v. D.C. 0-3A. Excellent condition, £4-47½. Carr. 37½p.

LAFAYETTE HA.800 SOLID STATE AMATEUR COMMUNICATION RECEIVER SIX BANDS 3-5-4, 7-7-3, 14-14-35, 21-45, 28-29-7, 50-54 Mc/s.

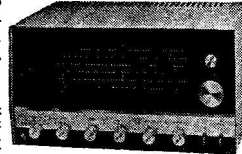

Dual conversion on all bands. 2 x 455 Kc/s. mechanical filters. Product detector Variable B.F.O. 100 Kc/s. crystal calibrator. "S" meter Huge slide rule dial. Operation 230v. AC or 12v. DC. Size 15" x 9 1/2" x 8 1/2". Complete with instruction manual, £57-50. Carr. paid (100 Kc/s. Crystal £1-97½ extra).

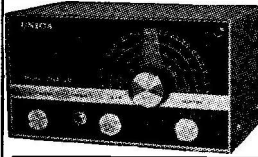

UNR-30. 4 BAND COMMUNICATION RECEIVER

Covering 550 Kc/s.-30 Mc/s. Incorporates variable FOB for CW/SSB reception. Built-in speaker and phone jack. Metal cabinet. Operation 220/240v. A.C. supplied brand new, guaranteed with instructions, £15-75. Carr. 37½p.

TRIO 9R59DS

4 band covering 550 Kc/s. to 30 Mc/s. continuous and electrical bandspread on 10, 15, 20, 40, and 80 metres. 8 valve plus 7 diode circuit. 4/8 ohm output and phone jack. SSB-CW - ANL - Variable BFO - S meter - Sep. bandspread dial - IF frequency 455 Kc/s. - audio output 1-5w. - Variable RF and AF gain controls 115/250v. A.C. Size: 7" x 13" x 10" with instruction manual, £57-50, Carr. paid. **SPECIAL OFFER!** Matching SP5D speaker supplied free with above receiver.

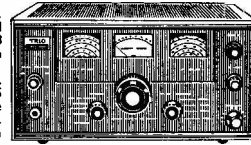

LAFAYETTE SOLID STATE HA400 RECEIVER

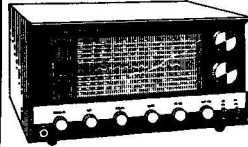

5 Band AM/CW/SSB amateur and short wave 50 Kc/s.-400 Kc/s. and 550 Kc/s.-30 Mc/s. F.E.T. front end. 2 Mechanical filters. Huge Dial. Product detector. Variable BFO. Noise Limiter, S Meter. 24 1/2" Bandspread. 230v. A.C./12v. D.C. Neg. earth operation. RF gain control. Size: 15" x 9 1/2" x 8 1/2". Wt. 18 lbs. Exceptional value, £45. Carr. 50p.

TRIO JR-500SE AMATEUR RECEIVER

7 separate ranges between 3.5 and 29.7 Mc/s. 7 valves, 2 transistors and 5 diodes plus 8 crystals: output 8 and 500 ohm and 5000 ohm phone jack. Crystal controlled oscillator. Variable BFO - VFO - AVC - ANL - S meter - SSB-CW - Stand-by switch - special double gear dial drive socket for connection to a transmitter. 115/250v. A.C. Mains. Size: 7" x 13" x 10" with instruction manual and service data, £65-00, Carriage paid. Package deal: JR500SE with SP5D speaker and HS4 headphones, £69-50.

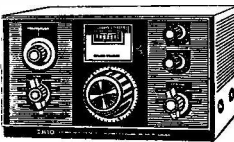

TRIO TS 510 AMATEUR TRANSCEIVER with speaker and mains P.S.U., £180.

TRIO JR310 AMATEUR BAND 10-80 Metre Receiver, £77-50.

B.C.221 FREQUENCY METERS Latest release 125 kHz-20 MHz. Excellent condition. Fully tested and checked and complete with calibrator charts, £27-50 each. Carr. 50p.

CLEAR PLASTIC PANEL METERS

First grade quality. Moving Coil panel meters, available ex-stock. Quantity discounts. Type MR.38P. 1 21/32in. square fronts.

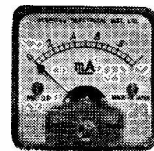

| | | | | | |
|-------------|-------|---------|-------|--------------|-------|
| 50µA | £2-10 | 1 amp | £1-60 | 150v DC | £1-60 |
| 50-0-50µA | £1-90 | 2 amp | £1-60 | 300v DC | £1-60 |
| 100µA | £1-90 | 5 amp | £1-60 | 500v DC | £1-60 |
| 100-0-100µA | £1-75 | 20mA | £1-60 | 750v DC | £1-60 |
| 200µA | £1-75 | 50mA | £1-60 | 15v AC | £1-60 |
| 500µA | £1-65 | 100mA | £1-60 | 50v AC | £1-60 |
| 500-0-500µA | £1-60 | 150mA | £1-60 | 150v AC | £1-60 |
| 1mA | £1-60 | 200mA | £1-60 | 300v AC | £1-60 |
| 1-0-1mA | £1-60 | 300mA | £1-60 | 500v AC | £1-60 |
| 2mA | £1-60 | 500mA | £1-60 | 5 meter 1 mA | £1-70 |
| 5mA | £1-60 | 3v DC | £1-60 | VU meter | £2-10 |
| 10mA | £1-60 | 10v DC | £1-60 | | |
| 750mA | £1-60 | 20v DC | £1-60 | | |
| | | 100v DC | £1-60 | | |

FULL RANGE OF OTHER SIZES IN STOCK, SEND S.A.E. FOR LEAFLET.

UR.IA SOLID STATE COMMUNICATION RECEIVER

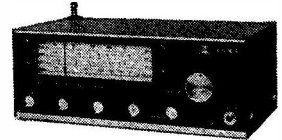

4 bands covering 550 Kc/s.-30 Mc/s. continuous. Special features are use of FET transistors, S Meter, built-in speaker, variable BFO for SSB reception, noise limiter, bandspread control, sensitivity control. Output for low impedance headphones. Operation 220-240v. A.C. or 12v. D.C. Size: 12 1/2" x 4 1/2" x 7". Excellent value. Only £25-00. Carr. 37½p.

TEIS TRANSISTORISED GRID DIP METERS

Six ranges. 440 Kc/s.-280 Mc/s. Operates on 9v. battery. Full instructions £12-50. P.P. 17½p.

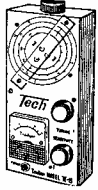

HANSEN SWR-3 BRIDGE

Impedance 52 ohms. Also operates as field strength indicator, complete with telescopic aerial, £4-25 each. P.P. 17½p. PL259 plugs to suit 37½p each.

HAMGEAR PRESELECTORS

PMIIA £9-20 & PMIIB £8-25. P.P.20p.

Latest Catalogue

Our New 6th edition gives full details of a comprehensive range of HI-FI EQUIPMENT COMPONENTS, TEST EQUIPMENT and COMMUNICATIONS EQUIPMENT. FREE DISCOUNT COUPONS VALUE 50p. 272 pages, fully illustrated and detailing thousands of items at bargain prices.

SEND NOW! STILL ONLY 37½p P. & P. 10p.



G.W.SMITH & CO. (RADIO) LTD

27 TOTTENHAM CT. RD. LONDON, W.1
3 LISLE STREET, LONDON, W.C.2
34 LISLE STREET, LONDON, W.C.2
311 EDGWARE ROAD, LONDON, W.2

Tel: 01-636 3715
Tel: 01-437 8204
Tel: 01-437 9155
Tel: 01-262 0387

All Mail Orders to -
11-12, Paddington Green,
London W.2
Tel: 01-262 6562

OPEN 9-6 MONDAY TO SATURDAY

Technical Books and Manuals

(ENGLISH AND AMERICAN)

AERIAL INFORMATION

| | |
|---|-------|
| ABC of Antennas | 88p |
| Aerials (By D. Sjobbema) | 67p |
| Aerial Handbook (Briggs) | 85p |
| Amateur Radio Antennas (Hooton) | £1.85 |
| Antenna Handbook, Volume 1 | £1.75 |
| Antenna Round-Up, Volume 1 | £1.45 |
| Antenna Round-Up, Volume 2 | £1.75 |
| Antenna Handbook, 12th Edition | £1.38 |
| Beam Antenna Handbook | £2.08 |
| Ham Antenna Construction Projects | £1.45 |
| Quad Antennae | £1.78 |
| S9 Signals | 85p |

BOOKS FOR THE BEGINNER

| | |
|---|-------|
| Amateur Radio (Rayer) | £1.35 |
| Beginners Guide to Radio (7th Edit.) | £1.10 |
| Beginners Guide to Electronics (N.E.) | £1.08 |
| Beginners Guide to Transistors | £1.10 |
| Beginners Guide to Colour TV | 80p |
| Better Short Wave Reception | £1.78 |
| Course in Radio Fundamentals | 60p |
| Foundations of Wireless and Electronics | £2.00 |
| Guide to Amateur Radio | 50p |
| How to Become a Radio Amateur | 57p |
| Morse Code for the Radio Amateur | 15p |
| Learning the RT Code | 25p |
| Novice Handbook, Tx & Rx | £1.80 |
| Radio, by D. Gibson | 70p |
| Radio Amateur Examination Manual | 45p |
| Short Wave Listener's Guide (N.E.) | £1.38 |
| Simple Short Wave Receivers (Data) | 87p |
| Understanding Amateur Radio | £1.35 |

GENERAL

| | |
|---|-------|
| Easibinder | 88p |
| Guide to Broadcasting Stations (16th Edit.) | 58p |
| How to Listen to the World 1971—Edit. | £1.35 |
| Radio Experiments (Rayer) | 88p |
| RCA Power Circuits | £1.55 |
| RCA Receiving Tubes Manual | £1.75 |
| RCA Transistor Manual (N.E.) | £1.75 |
| RCA Transmitting Tubes | £1.35 |
| Shop & Shack Shortcuts | £1.75 |
| Television Explained Vol. I | £1.35 |
| Television Explained Vol. II | £1.35 |
| Telecommunications Pocket Book (T. L. Squires) | £1.30 |
| World Radio & TV Handbook 1972 Edition | £2.80 |

HANDBOOKS AND MANUALS

| | |
|--|-------|
| Amateur Radio DX Handbook | £2.15 |
| Electronic Circuit Handbook, Vol. 1 | £1.40 |
| Electronic Circuit Handbook, Vol. 2 | £1.40 |
| Mobile Handbook, CQ | £1.38 |
| Mobile Manual, ARRL | £1.38 |
| New RTTY Handbook | £1.78 |
| Radio Amateur Handbook 1971 (ARRL) | £2.80 |
| Radio Amateur Handbook 1971 (ARRL) (Hard Cover) | £3.60 |
| Radio Amateur Operators Handbook 12th Edition | 51p |
| Radio Communication Handbook (RSGB) | £3.50 |
| Ritty A-Z (CQ Tech. Series) | £2.23 |
| Surplus Conversion Handbook | £1.35 |
| Transistor Substitution Handbook No. 10 | £1.10 |

USEFUL REFERENCE BOOKS

| | |
|---|-------|
| Amateur Radio SSB Guide | £1.57 |
| Amateur Radio Techniques (N/E) | £1.15 |
| Amateur Radio Construction Projects | £1.10 |
| Amateur Radio Circuit Book | 70p |
| Guide to Amateur Radio | 50p |
| Engineers' Pocket Book—5th Edit. | £1.10 |
| 'G' Call Book 1972 | 60p |
| Hams' Interpreter | 55p |
| Hints & Kinks, Vol. 8 (ARRL) | 60p |
| Radio Amateur Examination Manual | 45p |
| Operating an Amateur Radio Stat. | 23p |
| Radio Data Reference Book (3rd Edition) | £1.00 |
| Radio, Valve and Transistor Data (Iliffe) 9th Edition | 87p |
| Service Valve & Semiconductors Equiva- lents | 35p |
| Single Sideband for the Radio Amateur (ARRL) 5th Edition | £1.65 |
| Single Sideband (Theory & Practice) by H. D. Hooton | £3.45 |
| Sun, Earth & Radio by J. A. Ratcliffe | 89p |
| Surplus Schematics (CQ) | £1.20 |
| Transistor Pocket Book | £1.55 |
| Q & A on Audio | 52p |

VHF PUBLICATIONS

| | |
|-------------------------------------|-------|
| VHF Handbook, Wm. I. Orr | £1.77 |
| VHF Manual (ARRL) | £1.35 |
| VHF/UHF Manual (RSGB) N/E | £1.80 |

The above prices include postage and packing.

Delivery is from stock.

Available from **SHORT WAVE MAGAZINE**

Publications Dept., 55 Victoria St., London SW1H 0HF . 01-222 5341

(Counter Service. 9.30-5.15. Mon. to Fri.)

(Nearest Station: St. James's Park)

(GIRO A/C. No. 547 6151)

THE SENATOR CRYSTAL BANK

G3UGY

Phone: 01-769 1639

CRYSTALS FROM STOCK AT KEEN PRICES

SENATOR CRYSTALS: the first place to contact when you need good crystals quickly.

Here are just a few of the popular frequencies actually in STOCK now:

| kHz | Price | MHz | Price |
|---------------|-------|-------------------|-------|
| 100 in HC13/U | £2.50 | 28-045 in HC25/U | £1.60 |
| 455 in HC6/U | £1.75 | 28-500 in HC25/U | £1.60 |
| 500 in HC6/U | £1.75 | 30-000 in HC6/U | £1.60 |
| | | 32-500 in HC18/U* | £1.60 |
| | | 34-000 in HC18/U* | £1.60 |
| | | 34-500 in HC18/U* | £1.60 |
| | | 35-000 in HC18/U* | £1.75 |
| | | 35-500 in HC18/U* | £1.75 |
| | | 38-666 in HC18/U* | £1.35 |
| | | 40-000 in HC18/U* | £1.60 |
| | | 42-000 in HC18/U* | £1.60 |
| | | 42-000 in HC18/U* | £2.00 |
| | | 71-000 in HC18/U* | £2.00 |
| | | 72-050 in HC18/U* | £1.75 |
| | | 72-425 in HC18/U* | £1.75 |
| | | 72-500 in HC25/U* | £1.75 |
| | | 72-525 in HC18/U* | £1.75 |
| | | 96-000 in HC6/U | £2.00 |
| | | 116-000 in HC18/U | £2.80 |

* = Also in HC6/U

TWO more stock frequencies: 454 kHz and 456 kHz in HC6/U, useful for side-band filters etc. at £1.75 each.

And here's our STOCK range of BRAND NEW HC6/U 8 MHz for 2M:

8-002 8-007 8-012 8-018 8-021 8-0266 8-032 8-041 8-043 8-047 8-048 8-0555 8-058 8-061 8-070 8-081 8-092 8-100 8-104 8-107

All at £1.25 each, post free. These crystals pull well when VXO'd.

Here are some popular frequencies for VHF, home station, mobile channels and R.A.E.N. ALL IN STOCK:

| | |
|--|-------------------------------|
| 8-0555 MHz in HC6/U for TX × 18 = 145-000 MHz 2M Mobile | £1.25 |
| 44-7666 MHz in HC6/U for RX × 3 + 10.7 MHz | |
| | = 145-000 MHz 2M Mobile £1.80 |
| 8-100 MHz in HC6/U for TX × 18 = 145-800 MHz for RAEN | £1.25 |
| 45-0333 MHz in HC6/U for RX × 3 + 10.7 MHz | |
| | = 145-800 MHz for RAEN £1.80 |
| 12-975 MHz in HC6/U for RX × 12 = 10.7 MHz | |
| | = 145-000 MHz 2M Mobile £1.60 |
| 11-1916 MHz in HC6/U for RX × 12 + 10.7 MHz | |
| | = 145-000 MHz 2M Mobile £1.60 |
| 12-0833 MHz in HC6/U for TX × 12 = 145-000 MHz 2M Mobile | £1.60 |

Mail Order SENATOR CRYSTALS Dept. S.W., 36 Valleyfield Road, SW16 2HR

| | |
|---|------------------------------|
| 8-7825 MHz in HC6/U for TX × 8 = 70-260 MHz 4M Mobile | £1.60 |
| 29-780 MHz in HC6/U for RX × 2 + 10.7 MHz | |
| | = 70-260 MHz 4M Mobile £1.65 |
| 6-74666 MHz in HC6/U for RX × 12 = 10.7 MHz | |
| | = 70-260 MHz 4M Mobile £1.60 |
| 11-710 MHz in HC6/U for TX × 6 = 70-260 MHz 4M Mobile | £1.60 |

You'll find the above frequencies may be suitable for your PYE Cambridge, Ranger, Vanguard and other makes of ex-commercial R/T gear for the well-used mobile call channels. Check up with crystal multiplication data and crystal spec. in equipment manuals for suitability.

116-000 MHz in HC18/U NOW IN STOCK at £2.80. Ideal for 2M converter for I.F. 28-30 MHz, thus dispensing with need for osc. multiplication.

160m. modification on the FT-101. See February 1972 Radio Communication, page 84 using 7-520 MHz in HC25/U. In stock at £1.80.

PYE Cambridge 2nd oscillator crystal-change. See January 1972 Radio Communication, page 10 using 10-245 MHz in HC25/U. In stock at £1.60.

160m. modification on the JR-310. See December 1971 Short Wave Magazine, page 601 using 7-755 MHz in HC6/U. In stock at £1.80.

70cm. Converter—See December 1971 Short Wave Magazine, page 611 using 96-000 MHz. In stock at £2.00.

AVAILABLE SOON:

140-000 MHz and 130-000 MHz IN HC18/U. IDEAL FOR 2m CONVERTERS FOR I.F. 4-6 MHz and 14-16 MHz. THUS DISPENSING WITH NEED FOR OSCILLATOR MULTIPLICATION.

48-3333 MHz for × 3 = 145-000 MHz

46-6667 MHz for Converter.

New facility at SENATOR enables us to REDUCE PRICES on many made to order units, as follows:

| | | |
|-----------------|---------------------------------------|---------|
| 50— | 149.9 kHz in HC13/U | £4.60 |
| 150— | 499 kHz in HC6/U | £3.85 |
| 450— | 500 kHz in HC6/U | £3.50 |
| 501— | 999 kHz in HC1/U | £4.50 |
| 1-000— | 1-39 MHz in HC6/U | £3.20 |
| 1-40 — 20-00 | MHz in HC6/U (18/U & 25/U over 5 MHz) | £2.00** |
| 20-00 — 59.99 | MHz in HC6/U; HC18/U; HC25/U | £2.25** |
| 60-00 — 79.99 | MHz in HC6/U; HC18/U; HC25/U | £2.50** |
| 80-00 — 114.00 | MHz in HC6/U; HC18/U; HC25/U | £3.00** |
| 114-00 — 140.99 | MHz in HC6/U; HC18/U; HC25/U | £7.00 |
| 141-00 — 175.99 | MHz in HC6/U; HC18/U; HC25/U | £8.75 |
| 176-00 — 200.00 | MHz in HC6/U; HC18/U; HC25/U | £12.00 |

Under 1 MHz to ±0.1% tolerance. 1 MHz upwards to ±0.05% tolerance. Closer tolerances by quotation.

SONTRONICS introduce the BANDSCANNER, a 7 transistor Rx. covering a wider frequency range than any other Rx. on the amateur market. Comprises a high sensitivity, untuned, wide band cascade RF amplifier, covering the entire RF spectrum from 100 kHz to greater than 450 MHz. Uses UHF silicon planar transistors. Pocket sized and self contained in a strong moulded, white plastic case measuring 4 1/2" x 3 1/2" x 1 1/2"; complete with miniature loud speaker. Hear local transmissions on all bands up to 70 cm. Check modulation. Hear local radio-telephones, taxis, helicopters etc. Remember the strongest signal predominates; the telescopic aerial acts as an RF gain control. A must for D.F. events and Rallies. Use as an I.F. strip when servicing. Locate unwanted transmissions, i.e. spark interference. Detects powerful radar beams at over 2 miles. Sensitivity preset to receive a 5 watt Tx., whether on Top band or Two, at between 100 and 200 yards. Special introductory low price of £8.50 each, p. and p. and insurance 20p. PP3 battery 14p extra.

Terms of business: Mail order only, cash with order.

SONTRONICS
30 ASTBURY AVENUE, POOLE,
DORSET BH12 5DT.
Telephone: BOURNEMOUTH 58211

TRANSCEIVERS. Due to warehouse clearance, old stock, we have for disposal, few only Transceivers (approx. 40) No. 62 Mk. 2, made by Pye for the Navy and Army. Using a total of 11 valves, 1 RF and 2 I.F. stages, A.V.C., B.F.O., covering 1.5 Mc/s. to 10 Mc/s. (approx. 200 to 30 metres) in two switched bands. Can be used on RT or CW M.O. or Crystal. A very good internal ATU made of a rotating silver wire coil, tunable over the complete range, suitable for aerials fit. to 100ft., internal P.U. for 12 volt D.C. A meter is fitted for checking voltages A.V.C., etc. Housed in a metal waterproof case, approx. size 18" x 10 1/2" x 12 1/2". Supplied in very good used condition with headphones and mike, two spare valves, circuit, boxed. Few only at £12.50, carriage £1. Airtested £1 extra. Also 20 only V.H.F. TX-RX B44 Mk. 3 made by Murphy Radio for the Army, using 12 valves (B7 bases) covering 60-95 Mc/s. in three preset channels, crystal controlled. Tuning condenser is simply tuned to one of three adjustable preset positions, RX and TX, switched independent, internal large speaker and power unit for 12 volts D.C. Panel test meter, housed in alloy waterproof case, size 14 1/2" x 12 1/2" x 7 1/2" approx. supplied in new or as new condition with all six crystals, £8.50, carriage £1.50, or slightly used, no crystals, £6, carriage £1.50. **CRYSTAL CALIBRATOR No. 10.** Range 500 kc/s. to 10 Mc/s., up to 30 Mc/s. on Harmonics. Size: 7" x 7 1/2" x 4". Power 300 volts HT, 12 volts LT. The Calibrator can plug into a Power Socket on the 62 Trans-Receiver which it was normally used with. Supplied in good used condition with circuit, £3.75, Post 50p or BRAND NEW IN CARTON with operating Manual and Circuit connectors to set £5.75p, post 50p.

JOHN'S RADIO
Dept. B, 424 BRADFORD ROAD, BATLEY, YORKS.

SOLID STATE MODULES

Telephone: HUDDERSFIELD 23991

63 WOODHEAD ROAD,
SOLID, LOCKWOOD,
HUDDERSFIELD, HD4 6ER

WE NOW STOCK IN ADDITION TO OUR OWN MANUFACTURE GEAR THE RANGE OF
YAESU MUSEN AMATEUR GEAR

FT101 Transceiver £240. Speaker £10. FT200 Transceiver £134. AC supply £38. FT401 Transceiver £215. FT560 Transceiver £195. Fr400 Super de luxe Receiver £160. The YD846 hand mike £15 and the YD844 Table Microphone at £12.

This we offer with service facilities at our premises—often carried out while you wait, as we do with our own equipment.

SECONDHAND GUARANTEED GEAR

KW Atlanta and P.S.U. £165. Eddystone EA12 £160. Come and try this gear.

THE SENTINEL DUAL GATE MOSFET 2 METRE CONVERTER

- ★ Low noise figure 2dB.
- ★ Gain 30dB.
- ★ Dual gate MOSFETs in the RF amplifier and mixer for excellent overload and cross modulation characteristics.
- ★ Size only 2½" x 3" x 1½" aluminium case—silver hammer finish with black trim.
- ★ Stock Ifs: 2-4 MHz, 4-6 MHz, 9-11 MHz, 14-16 MHz, 18-20 MHz, 23-25 MHz, 24-26 MHz, 27-7-29-7 MHz, 28-30 MHz.
- ★ Price: £13-75.

THE SENTINEL LOW NOISE FET 2 METRE PRE-AMPLIFIER

- ★ Low noise figure 1dB.
- ★ Gain 18dB.
- ★ Have you noticed how many of these are being used with Commercial Base stations and mobiles. "It makes all the difference between not hearing a signal and being able to work him!"
- ★ Size: matching our Sentinel Converters. Price: £6-50.

SM70 70 cms. CONVERTER

- ★ Low noise figure 4-5dB.
- ★ IF output 144-146 MHz. By using the 70 cms. converter with a 2 metre converter you can have a high performance 70 cms. unit at a low price—£13-75.

We believe that all equipment and components advertised will be in stock as you read this, but you can always ring for confirmation.

SM71 70 cms PRE-AMPLIFIER

- ★ Low noise figure 3-5dB.
- ★ Gain 10dB. Price: £6-50.

THE SPITFIRE 2 METRE A.M. TRANSMITTER

- ★ 5 watts input. At least 2 watts output.
- ★ 12 volts operation.
- ★ Modulation wave shaping gives good, clean 100% audio.
- ★ Size 4½" x 2½" x 5½" deep.
- ★ Audio monitoring point for headphones.
- ★ Front panel meter indicates R.F. output and modulation. Price: £22-00.

THE SPITFIRE MODULATOR

- ★ Same size and appearance as the transmitter.
- ★ 100% modulates our transmitter.
- ★ FET input circuit for use with high or low level impedance microphones.
- ★ Price: £10-00.

SOLID STATE 9 MHz SSB GENERATOR

- ★ Selectable USB, LSB and CW.
- ★ 0-2 volts into 80 Ohms output.
- ★ Sideband suppression 45dB. Carrier suppression 50dB.
- ★ A sound basis for your SSB transmitter.
- ★ Price £11-00 less filter and carrier crystals.
- ★ XF-9A filter £11-00. Carrier crystals £1-50 each.

We can supply from stock the range of KVG 9 MHz filters: XF-9A SSB 2-5 KHz £11-00. XF-9B SSB 2-4 KHz £15-00. XF-9C AM 3-7 KHz £15-00. XF-9D AM 5 KHz £15-00. XF-9M CW 0-5 KHz £11-50. Carrier crystals £1-50 each.

Plessey SL600 series ICs in stock and other components listed below: Erie 1000pF discoidal feed throughs 6p each, 55p per doz. Erie 1000pF discs 5p each, 50p per doz. Tubular ceramic trimmers 6pF, 12p each, 120p per doz. 18pF, 17½p each, 180p per doz.

Advertising in "Short Wave Magazine" guarantees the largest and most effective coverage of the U.K. radio amateur interest

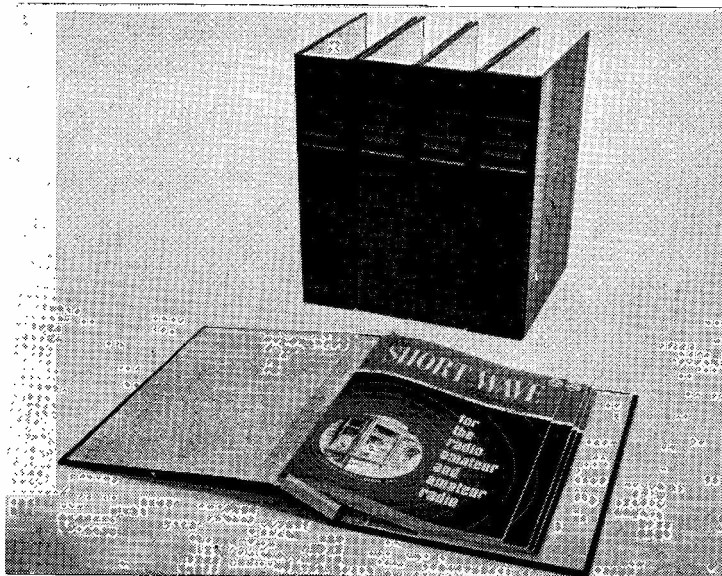

CREATE YOUR OWN REFERENCE LIBRARY

The "EASIBINDER" is designed to bind 12 copies of the Magazine as you receive them month by month, eventually providing a handsomely bound volume for the bookshelf.

No need to wait until twelve copies are assembled. As each copy is received, it is quickly and simply inserted into the binder. Whether partially or completely filled, the binder is equally effective, giving the appearance of a book, with each page opening flat.

Strongly made with stiff covers and attractively bound in maroon Leathercloth and Milskin, the binders have only the title gold blocked on the spine.

Price 88p. post free.

PUBLICATIONS DEPARTMENT
SHORT WAVE MAGAZINE
55 VICTORIA STREET
LONDON, SW1H 0HF

ADVERTISERS
INDEX

| | PAGE |
|--|-------|
| Amateur Electronics (G3FIK) | 8 |
| Baker, John R. R. <i>inside back cover</i> | |
| Belding & Bennett (Morse) | 64 |
| J. Birkett | 60 |
| "BoomMike" | 63 |
| Chiltern Amateur Radio Club | 56 |
| Colomor Electronics, Ltd. | 57 |
| Derwent Radio | 56 |
| Echelford Communications | 59 |
| Eddystone Agents | 6 |
| Eley Electronics | 63 |
| Forth Motor Co. | 57 |
| General Merchandise Credit Ltd. | 57 |
| G.W.M. Radio | 59 |
| Hamgear Electronics | 62 |
| Heath (Gloucester) Ltd. ... | 7 |
| Holdings Photo-Audio Centre (Trio) <i>...inside back cover</i> | |
| Home Radio (Components) Ltd. | 1 |
| Imhofs | 61 |
| Johns Radio | 11 |
| K.W. Electronics | 14 |
| Lowe Electronics | 9 |
| May (Leicester) Ltd. | 56 |
| Markham Electronics | 56 |
| Minitenna Communications <i>inside back cover</i> | |
| Mosley | 1 |
| Newbery, Graham | 62 |
| New Forest Printing Co., Ltd. <i>... inside back cover</i> | |
| North West Electrics | 5 |
| P. & P. Developments <i>inside back cover</i> | |
| Partridge Electronics, Ltd. | 14 |
| Radio Shack, Ltd. | 8 |
| R. T. & I. Electronics, Ltd. | 4 |
| Senator Crystals | 11 |
| Small Advertisements | 58-64 |
| Smith, G. W. (Radio) <i>inside front cover</i> | |
| Solid State Modules | 12 |
| Sontronics | 11 |
| Spacemark, Ltd. | 60 |
| SSB Products | 58 |
| Stephens-James | 4 |
| Strumech Engineering | 61 |
| S.W.M. Publications <i>back cover,</i> 6, 10, 12, 56, 58 | |
| Taurus Electrical Services | 64 |
| The Amateur Radio Shop <i>back cover</i> | |
| The Radio Shop (Bristol) <i>inside back cover</i> | |
| The Trading Post | 63 |
| J. & A. Tweedy (Electronic Supplies) Ltd. | 57 |
| Western Electrics | 2, 3 |
| Yukan | 63 |

SHORT WAVE MAGAZINE

(GB3SWM)

Vol. XXX

MARCH, 1972

No. 341

CONTENTS

| | Page |
|---|------|
| Editorial— <i>Disruption</i> | 15 |
| Communication and DX News, by E. P. Essery, G3KFE | 16 |
| Top Band Transverter for Transceiver Operation, by F. Powell, G3SEL | 23 |
| Using the Roller-Coaster Coil Unit, by F. G. Rayer, A.I.E.R.E., G3OGR | 27 |
| The Phase-Locked Loop, by J. M. Osborne, M.A., F.Inst.P., G3HMO | 29 |
| Mobile Rally Fixtures | 34 |
| Loading Up a Wire for Top Band, by J. S. Cushing, G3KHC | 35 |
| "SWL"— <i>Listener Feature</i> by Justin Cooper | 38 |
| VHF Bands, by A. H. Dormer, G3DAH | 44 |
| TVI and Stubs, by E. Johnson, G2HR | 49 |
| The Month with The Clubs— <i>From Reports</i> | 50 |
| New QTH's... .. | 55 |

Managing Editor: AUSTIN FORSYTH, O.B.E. (G6FO/G3SWM)

Advertising: Maria Greenwood

Published at 55 Victoria Street, London, SW1H-0HF, on the last Friday of the month, dated the month following. Telephone: 01-222 5341 & 5342

Annual Subscription: Home: £2.75 (£3.00 first class) post paid
Overseas: £2.75 (\$7.00 U.S.), post free surface mail

Editorial Address: Short Wave Magazine, BUCKINGHAM, England

AUTHORS' MSS

Articles submitted for Editorial consideration must be typed double-spaced with wide margins on one side only of quarto or foolscap sheets. Photographs should be lightly identified in pencil on the back with details on a separate sheet. All drawings and diagrams should also be shown separately, and tables of values prepared in accordance with our normal setting convention—see any issue. Payment is made for all material used, and it is a condition of acceptance that full copyright passes to the Short Wave Magazine, Ltd., on publication.

© Short Wave Magazine Ltd.

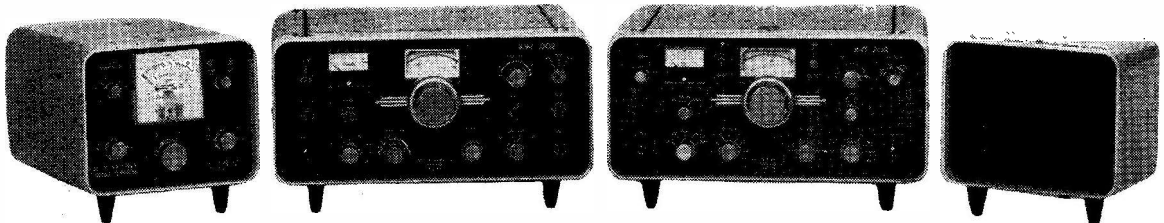

KW 107 ANTENNA
Tuning SYSTEM

KW 202 RECEIVER, 10-160 metres SSB/AM/CW, with Mechanical Filter, built-in 'Q' Multiplier (Peak & Null), 500 kHz VFO covering all Bands.

KW 204 TRANSMITTER. 10-160 metres SSB/AM/CW. Successor to the famous KW "Vespa"—Perfectly matches the KW202 Receiver and is similar in appearance. 180 watts p.e.p. from trustworthy 6146's. Built-in Power Supply. Provides "side tone" CW monitoring. A beautiful compact efficient unit. Price £145 carriage extra.

KW 202 SPEAKER

Two Speed VFO Drive. Excellent Sig./Noise and sensitivity performance. Very attractive (similar in appearance to KW2000B). 100 kHz Crystal Calibrator price £140 carriage extra.

2 Great Transceivers
DELIVERY IMMEDIATELY, FROM STOCK

KW2000B 10-160 metres SSB
TRANSCIVER: 180 watts PEP
10-160 metres, complete with A.C.
p.s.u., VOX P.T.T., I.R.T./I.T.T.

£240 carriage extra.

KW ATLANTA
10-80 metres.
KW Atlanta and A.C.
p.s.u.

£210 carriage extra.

or separate units

Matching **KW1000 LINEAR AMPLIFIER** for KW 204 and KW 2000B—also available. 1200 watt pep max. Pair T160L/572B tubes including 2-5kv Power Unit, built-in to KW2000B style cabinet £135 carriage extra. **KW 101** Standing-Wave-Ratio meter, £9.25. **KW 103** SWR/Power meter 0-100 & 0-1000 watts £12.50*. **KW103** with Dummy Load and Coax Lead, £20.50*. **KW 107** Antenna Tuning System including E-Z Match, SWR Ind., Dummy Load, Antenna Switch, 5 position, £40.00*. Also KW Trap Dipole with twin feeder and 4 other types (only the original Trap from KW is good enough for you), KW E-Z Match ATV, KW Low Pass Filters, KW & HZP Baluns, etc. *Carriage extra.

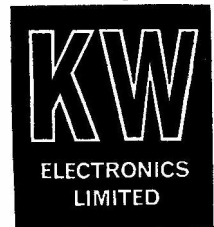

All Equipment Available through accredited agents

TRADE-IN EQUIPMENT AND MANY IMPORTED ITEMS AVAILABLE WRITE FOR DETAILS TODAY

K. W. ELECTRONICS LIMITED: 1 HEATH STREET, DARTFORD, KENT
Tel.: Dartford 25574 Cables: Kaydublew Dartford

EASY TERMS ON EQUIPMENT AVAILABLE OVER 12, 18 OR 24 MONTHS

G3LOL/MP4BDG using 5 WATTS INPUT to a **TEN-TEC PM3A** transceiver and a

JOYSTICK V.F.A.

RGD.

system has received QSL cards CONFIRMING the following reports of his signal on 14 mHz.

RST 599 in each case from WIHRJ, SM4EMO, UY5UW, UWICX and 589 from UY5OQ (to quote just a few).

THE ABOVE IS NOT JUST A TESTIMONIAL BUT AN ESTABLISHED PROVEN FACT—OTHERWISE WE ARE LIABLE UNDER THE TRADES DESCRIPTION ACT! LACK OF SPACE IS NO PROBLEM. WE HAVE A SYSTEM TO SUIT YOUR PURPOSE—INCLUDING A RANGE OF LOW PRICED CLEARANCE LINES—JUST SEND A 3p STAMP TO :

PLEASE SEE JAN. and FEB. ADVERTS.

YOU HAVE EARTHING PROBLEMS ?

PLEASE CONSULT US!

Telephone (THANET) 0843 62535

DEPT. SD



FOR THE RADIO AMATEUR AND AMATEUR RADIO

The
SHORT WAVE
Magazine

E D I T O R I A L

Disruption

Nobody seeing these lines needs to be told that we have been sliding towards a period of national chaos. At the moment of writing, we cannot be sure when you will see this—or even if you will get it at all.

Apart from our own difficulties in production—which are relatively minor and can be overcome, so long as the mails keep moving—our printers have considerable problems on the mechanical side because of the heavy power cutting—and these are likely to get worse.

We shall, of course, push on to meet our regular publishing schedule and aim to get each issue ready for appearance in the usual way.

So far as this issue is concerned, it may be that it will not have been possible to include the Index to Vol. XXIX, which is a loose supplement handled separately. It could also be that many of the dates given this time—for feature deadlines, Club activities and so forth—will have been passed by the time general distribution has been achieved.

Here, readers can help us by sending in their correspondence for CDXN, VHF Bands and Clubs as soon as possible, so that we can get preparations for the issue dated April well forward. The same applies to all advertising material, including Small Advertisements.

This country has faced crises before—many of them—and, in one way or another, they have been overcome. This one need be no exception, so long as we all keep going with the objective of getting things back to normal as quickly as possible.

*Austin Forster,
G6FO.*

WORLD-WIDE COMMUNICATION

COMMUNICATION and DX NEWS

E. P. Essery, G3KFE

PERHAPS the main event of the month, at least as far as G3KFE is concerned, is that the pundits have been proven right—his 28 gauge Top Band half-wave fell down. However, it has been serving since October 1968 without any maintenance in that time beyond renewing a lead-in carried away by snow falling from the roof. And, it must be said, it would not have come down even now had not a branch of the tree grown across the aerial so that the wind could get a purchase in its attempts to get that wire down!

Other deterrents to operating in the month under review could generally be lumped under weather, both wet and cold, the ever-increasing amount of assorted man-made electrical pollution of the ether, a bout of construction and trying, as always, to find a means whereby one can be in the shack whenever DX is about and yet still earn a crust. Otherwise, conditions have been quite tolerable!

However, enough is enough—let us hear more of the chaps who actually *work* the stuff, making a start with 28 MHz.

Predominantly, what few contacts there were on *Ten* were made in a North-South direction, rather as one would expect at this stage in a sunspot cycle. W6AM (California) reports but one QSO, with VP2AX, on CW; G3NOF (Yeovil) found most of the going to be North-to-South, but he did note the odd opening to East Coast W's. It all boiled down to CR6IS, FL8MM, KV4DC, W2, W3, W4, WØ, ZS's, 9H1BX and 9J2RC.

Fifteen

Again, one has to say it, like the curate's egg—good in parts! G3NOF again: Virtually, he got no joy out of the band at all in the morning sessions, finding it full of short-skip Europeans at strengths umpty-over-nine, but the Yanks were showing

their faces by 1300, staying till around 1800z. SSB contacts were made with KR6SK, MP4MBM, VK2AU, VK2FA, VK2IH and W's.

Last month we mentioned that G2DC (Ringwood) was having to spend far more time than before on SSB; pleased to hear, Jack's "fist" is responding to treatment and the rest from brass-pounding. However, SSB it was, and it resulted in QSO's with DU1EJ, EQ2BQ, ET3TH, JX2HK, KV4AD, PZ1CU, TJ1AV, VU2HH, VU2AAA, VP8MM, VK1AD, VK2WD, VK2BCY, VK3APU, VK3AZ, VK5FM, VK5DO, VK5GM, VS6BE, ZL3RB and 5Z4KZ.

A long and most interesting letter this month from Jake, GM3OOK (Irvine), who, like your conductor, lost his LF-Band aerial. However, his is repairable by straightening and the replacement of the top four feet, and the HF-Band ground-plane is complete and undamaged although on the floor. Problems notwithstanding, GM3OOK was able to use his CW to get to grips with EA9EO, ET3USE, FL8HM, JY6FC, VP2LY, VQ9LW, YA1OS, ZC4CB, ZE1BL and ZS1OU, the RF being generated by an 813 running 150 watts input.

W4WFL/1 has been somewhat inactive this past month, although, as will be noted elsewhere, Morgan did contrive to be on for the *CQ* Top Band contest. A little CW activity on Fifteen collected him up a gaggle of Frenchmen for a couple of their awards to be brought a little nearer to completion; also ET3US, for a new country.

As a result of some Club discussions about TVI, and trapped aeriels, such as the Hy-Gain or Mosley verticals and beams, your scribe has been doing a bit of thinking, and experimenting. It is usually stated that for the poor souls in a Ch.1 BBC TV area, Fifteen is all but impossible, Twenty being a much easier proposition to deal with. Now, a 14 MHz dipole, or a trapped multi-bander, will, by

its very nature, radiate odd harmonics of 14 MHz as well as it does the fundamental, but a 21 MHz dipole will not accept second-harmonics; however, a trapped multi-bander presented with 21 MHz second-harmonic will radiate it in exactly the same way as it does the 14 MHz third-harmonic just mentioned. But since both these signals should be well down on the fundamentals, little or no problem should arise at the TV set other than that caused by the TV set itself generating such harmonics. For G3KFE, a TV set operating off the same power socket as the transmitter acts as a monitor; on the transmitter there is a low-pass filter of standard K.W. design, plus a stub cut to act as a quarter-wave open-circuit at a frequency between sound and vision, trimmed on the TV set to remove as much sound and vision as possible, and then fitted between the low-pass filter and the ATU or aerial. This latter precaution, the stub, seems to be the vital one here, and its removal causes wide-spread gnashing of teeth. At the TV sets, a high-pass filter is needed in almost all cases, plus, usually, a ferrite ring to get the RF off the outer of the coax; should mains filtering be needed, another ferrite ring on the mains lead as close to the TV set as may be is a help, but it is rare to find the interference is mains-borne in areas where the mains are below-ground distributed. And, with that, Bob (should be) uncle!

Opening the letter from G4AMJ (St. Ives, Cornwall) we find him complaining that, having made such a good start at the DX on Fifteen, he now has to go to school five days each week and then has TVI on Channel 1 over the weekend! Thus, for this trip his SSB crop was 9J2RA, W1-3, and on CW the same W call areas, also YO4WB/MM and Europeans. And, the battle with G4AMT continues unabated, one having scored more countries and t'other got more confirmed.

For the Marconi 70th Anniversary celebration, the Cornish Radio Amateur Club set up an amateur-band station at Poldhu, Cornwall, signing GB3SMA. The range of activities covered included RTTY, and here we see G3PPT operating the machinery—unfortunately, no RTTY-contact log was included in the report.

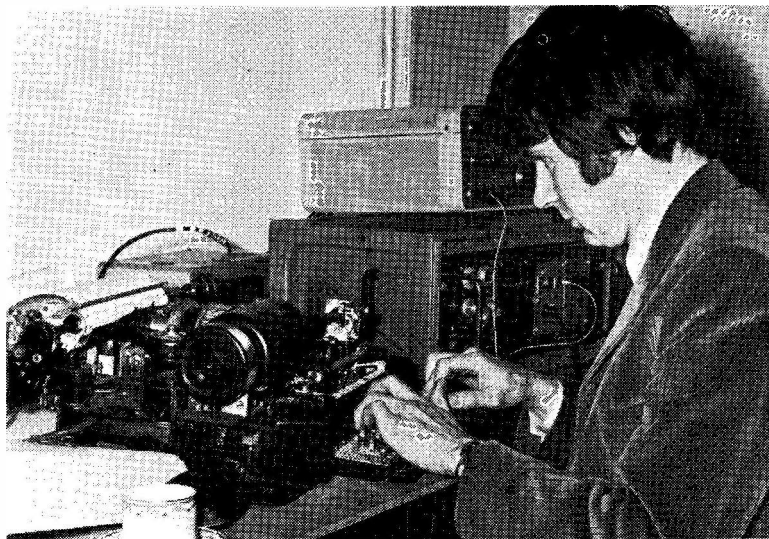

Twenty

More signs of enthusiasm here—indeed, during the past month one could switch on during the evening for an idle listen and have at least a reasonable hope that the band would be open to *somewhere*, even if only to I-land!

G4AMJ notices more DX is about on Sideband than CW—true enough, sadly for DX operating standards. Brasspounding resulted in a couple of VP9GK contacts, CT1UM for a new country, W1-4, and W8-9. Moving up to the other end of the band, mike in hand, did the trick with OX3ER, VP2AA, EA8HR, VP9AT, IS1LO, PZ1AN, 6W8DY, 9Y4T, VP2VAM twice, VP9CB, VP9GN, EA8HS, PY7BPE, PY2CK, PZ1DR, 9J2GJ, PJ2AW, VP9GO and CR7IZ.

QRP can still get heard, even on poor aerials, says G3KGM (Sidcup), citing as example a QSO with one watt to a transistor final stage, by G3XIZ, on 14020 kHz; IIEGG gave a 559 report, and G3XIZ at the time was using an indoor Joystick as aerial, with a Drake 2B as receiver. Incidentally, G3XIZ is crystal-controlled at that frequency.

Only afternoons have interested G2DC, who found the European QRM somewhat annoying. VK's were peaking to around 1500z on the short path. The SSB raised HS1AFB, VQ9LW, VQ9R, also VK6's 'CT, 'CF, 'HD, 'KK, and 'LK, 4S7DA, 5X5NA, 9V1QB,

9M2DQ, all W call areas, VE1-7, MP4MMB and MP4MBC.

The 813 PA at GM3OOK was pressed into service on Twenty, to make two-way contact with CT3AW, KG4EO, TA1ST, VS6FE, ZS6AJS and ZL2AI.

G3NOF wonders whether the apparent lack of VK/ZL signals in the mornings has relation to band conditions or his own operating times—like so many of us, Don has to go to work! Evenings too have seemed patchy, although QSO's were achieved with A2CAH, A2CAL, CR6GA, EL2P, KA2AI, KA2RD, PJ2AW, PY7VON/M, VK's, VP2VAM, VP9AT, W7HQC, W7HXA, W7KSG, ZL1ASM, ZL2ASM, ZL3RB, ZL3TD, ZL4IB, ZE1DP, ZE3JO, ZS's, 5H3LV, 6W8AL and 9J2JY.

Twenty for W6AM (Palos Verdes, Calif.) can be divided into two entirely separate activities, namely DX'ing from Rhombic Farm on the one hand and mobiling on the other, not to mention entertaining DX visitors. One such was JA1BK, who recently signed XU1AA from Cambodia. Operating CW from the main rig, Don came up with such as HA9RE, EA2IA, VR1AA, G6UF, ZL2AFZ, I8IPB (W2GHK of DOTM in disguise!), CO2FC (later turned into a phone-patch), CR6AI, FK8KAA, VR5FX, KX6EB, G3XAR/A, G3KHK/4X and F08DF. Some of these calls would not be DX to us but they are to him,

from California!

For the chaps at the top of the DX tree, a new thought is offered by G5ARI/G5ARH. Robert and Roland have a brother back in the States, who has it on pretty good authority that NASA have had a firm proposal for amateur-band equipment in *Skylab 1*, due to be lifted off in 1973—several of the astronauts being amateurs. G5ARH/G5ARI also mention that the *Skylab* orbit will be clearly visible in the U.K., and, indeed, an astronaut working outside the satellite could be seen by telescope under good astronomical conditions.

If you lack GC on Twenty—not one of the easiest ones from U.K.!—take note that GC3GPL is now on the band and looking for QSO's, although he still has plenty to do in the house after the move from the mainland. In addition there is also Top Band, which will be run up as opportunity serves; GC3GPL, by the way is in Jersey.

G4ACQ (Erith) just missed the deadline, last time out, to get his score into the final Six-Band listing, before having to move to a new QTH—a little bird tells us Len has chosen it for its radiating properties alone!

Aerials are fascinating, ruminates G3PTO (Bristol)—John having organised himself a garden of the right length to indulge his hobby! The present arrangement is a "5RV", hanging between poles about

40 feet high, driven by an NC-200 on the transmitting side, and a "CW-oriented G2DAF variant" as receiver. This, in limited time, came up with WA3CXG, W1HRJ, WA2YSD, W1DBS, ZS6ME, W7MF, K4TV, JW2IK, UK9UAE, JA9FE and UVØAB—the gotaways list including various VK and ZL.

Thoughts on Top Band

Whatever can be done with the optimists who slide down to the bottom end of Top Band, and happily call "CQ DX" the while

BRIEF DX DATA

| Call | Details |
|---------|---|
| ACSTV | Yonten on 14035 kHz, 1225z. T. Yonten, Dechhentshe P.O., Thimphu, Bhutan. |
| "EAØVU" | A phoney, says VE1AL, who is <i>not</i> his QSL Manager. |
| VK9JW/M | DX-pedition to Mellish Reef, late May, early June, on 3650 kHz QSX 3660; 7090 SSB QSX 7100 kHz up; transceive on the hour, CW 3515, 7015, 14015, 21015, 28015, QSX 5 kHz up. QSL via VK3JW, Box 239, Bairnsdale, Victoria 3875. |
| V55PW | Often checks into the S.E. Asia net, 14320 kHz, 1200z; QSL via DK5JA. |
| XF4. | March 16-23. XE3EB will be 6D4EB on 14195, QSX 14205 up, XE1FFC 6D4FFC on 21295, QSX 21305, 21395; 28595 QSX 28605; XE1J 6D4J, 3795 QSX 3805-3855; 7095 QSX 7215-7255 kHz. |
| 5T5.. | The 40-metre "5T5AD" saying QSL via K4BC is a phoney. |
| 9LIRP | New QSL manager now G3LQP — was GW3AX, or QSL direct to Ray Parsons, c/o Bata Shoe Co., Ltd, Box 111, Freetown, Sierra Leone. |
| 5R8AB | Hopes to be on 7 MHz. QSL to G3WRN. |
| JDIACH | Ogasawara, for three weeks from about February 7, all bands but mainly 14195 SSB, 0800 to 0900z. QSL, with IRC and envelope for return, or s.a.e., to JA3GZN. |

Reporting the HF Bands

another gang are frantically trying to read an S2 signal from VK or somewhere? Surely, by now, it is well enough known that the LF section of 160m. is DX Alley? Or is it? One wonders if the W method of dealing with their similar problem, with local natters blanketing the area in which the DX calls the W's, could be adopted over here? It relies on the co-operation of all the chaps who use the band for DX contacts; they are asked to send a note to the offender, through the post, explaining what it is all about, and *why* the DX wants to get through on this frequency rather than another. Go on and tell him the frequencies G's transmit on, so he can listen if he wants, and ask his co-operation. This approach seems to work in the States quite well—why don't we try it here?

Talking of thoughts, we have a recent QSO with G3RKJ to record; it has to be admitted that Neill has a mighty big signal—but some new chum quite local to him called him and openly accused G3RKJ of running over the limit, his reasoning being that "the signal is too strong for ten watts!" Faced with such a situation what does "A" do? G3RKJ contented himself with a rude comment on the back of a QSL sent post-haste to the offender; but your scribe would have felt a little more inclined to go round and clip the offender's ear. Any *other* suggestions?

Since these thoughts have been about Top Band, it seems logical to go through the 160-metre mail at this juncture.

Advance notice is given by the University of Manchester group that they are going to do Western Scotland, and in particular the islands of Jura and Islay, at the end of June, as many as ten operators being carried to ensure coverage of all bands. Anyone who wants to lay on skeds could get in touch with G3ZNS, hon. sec. of the University Club, *QTHR*.

Cambridge University next, and G4AVK writes to say that their

HB9 and HBØ targets are definite; there is also a chance that they may be able to activate 4U1ITU as well. The schedule calls for them to be on from HB9 between March 13-16 inclusive, with 4U1ITU operations, if possible, on the last two of those dates, so that the 17th to 20th are available for the Liechtenstein (HBØ) activation.

G2HKU is *still* getting cards sent to G3HKU—Ted is so cheesed about this, that he actually has to keep envelopes at G3HKU to avoid the latter's kindness being imposed upon. Worse even than that are the cards which lately have come in from some stations bearing just the word "Greetings"—the idiot who thought of that deserves the fate such cards would get if they landed on your conductor's mat—File 999, otherwise known as the WPB. However, G2HKU's enthusiasm is unabated, and Ted managed to work, on 160m., DK2UN (phone), plus DL1CF, DL9KR, OE8MI, GM3IGW/A, GM3YCB, OK1FAR, OK1HBT, OK1AYY, OL1AOH, OL1API, OK2BEC, OK2HI and OK2PDN; heard but not worked included EQ2BQ and KV4FZ.

Last month we mentioned G3TR (Crawley) in the VK-on-Top-Band context; VK3CZ and VK5KO were worked solidly, and confirmed—so as a result of fifty evenings watching since November, at the periods given last time, John now has *four* VK QSO's on Top Band in his log! That means real *patience*, always the most useful attribute of a DX operator, Congratulations, G3TR, on these, on HZ1KE, and for a near-miss with VS6DO, when they heard and called each other but missed out on reports. John is now after his 160-metre WAC.

Another VK exponent on Top Band is G2JL (Penzance) who was encouraged to try by a reception report from out there at Christmas 1970. His story is worth repeating in detail: December 11, 2100z, called VK6NK, at 459, missed reply due to splash from Brest on 1806 kHz; December 14, VK6NK answered a

Members of the Cornish R.A.C. at the Poldhu Hotel, Cornwall, near the original Tx site, for the 70th Anniversary of the historic Marconi Trans-Atlantic test on December 12 1901. Their station GB3SMA was organised for all-band operation for the six days December 11-17 last, during which 1158 contacts were made on the five bands 15-160m. The sister-station at the Newfoundland end was VB1SMA St. John's. This shot includes C.R.A.C. members G3FXL, G3VVK, G3XC (operating), G3RMG, G3NKE (pipe) and G3OCB (lower right).



CQ, lost in QKM at 1957z; December 18, at 2125, worked a *pirate* "VK6HO," who later raised G3SZA—the W's found him out, apparently; December 19, worked VK6NK, peaking 569 at 2052; heard him again the following night at 2105z but only 229. On Christmas day, HB9NL got through at 2110, and G2JL worked VK3ARS at 2027 on January 2, but doubts his authenticity. January 7, and twice on the 8th, ZD9BM appeared through the noise, between 2023 and 2120z. On January 20, a solid, genuine and QSL'ed QSO with VK6HD at 2115—the VK worked HB9CM the following night. At 2045 on January 22 came a 4S7DS, back to a "CQ VK" call. January 28 brought VK3CZ back to a CQ at 1930z, although there was some teleprinter QRM. All this painstaking reporting by G2JL and G3TR concerns a Top Band activity few of us have the patience or ability to bring off—but it does seem to show that the G/VK path is not as tough as we have believed, with *two* peak times to watch, even though both are very vulnerable to QRM. By any standard, VK/G on Top Band is about the ultimate in DX.

Another OT call next; G2DC *couldn't* miss the CQ 160m. Test, screws or not, and so Jack hooked up his Wheatstone tape machine to send the CQ's, and by carefully

choosing his times was able to make a claimed score of 8608 points, including contacts with DL1CF, DJ5PN, ZL7AA, DL9KR, DKØFV, EQ2BQ, HB9AJU, HB9CM, HB9NL, HB9UD, HB9QA, HZ1KE, PE2EVO, OE1KU, OE8MI, W1BB/1, WIHGT, W2LWI, VO1FB, 46 OK/OL stations and all U.K. countries except GC.

Letters from G3LIQ (Hull) report having received a fine QSL card from ZD9BM, and another from VK3CZ, the latter saddened at the time of the QSO also to be hearing HB9NL, DL9KR and G3SZA at 579 but unable to raise them. Later, on February 5, VK5KO managed, after much effort, to attract the attention of HB9NL, only to be blotted-out by a fat carrier.

The picture during the Test was quite interesting, too, from Stateside, avers W4WFL/1 (Farmington, Conn.) who looked in on it and heard thumping great signals from DL9KR, G2DC, G3SZA, GM3YCB, GW3UPK, G6BQ, HR2HH, KV4FZ, VP9BO and W4BRB/VP7, although he only tickled with the last two.

W6AM tried his hand at Top Band as well; Don managed W4BRB/VP7, W7DL/7, W6YY and K5FIQ, all calls any G would *love* to work!

Next we must turn to Stew Perry,

W1BB (Winthrop, Mass.), for his invaluable *Top-Band Bulletin*. Perhaps the most important idea this month crops up in this newsletter, when W1BB quotes Rolf Rasp, PY1DVG, as proposer of an HF-Band Net, purely for the purpose of meeting, say, weekly, to exchange Top Band information and news, set up skeds, and so forth. Anyone interested please write direct to Rolf at P.O. Box 51-ZC-00, Rio de Janeiro, Brazil. Another idea of interest to the chaps who need a radial farm that is easy to make comes from W4BRB, who uses the inch by fifty feet aluminium foil rolls available in the shops, and has put down a total of three hundred square feet of the stuff as radials—this should be pretty free from corrosion, and at the same time better electrically than wire, due to the greater ground capacity for a given length. Certainly W4BRB now puts out a big signal. That fantastic great signal from DL9KRA may have been lost by the latter's removal from New Isenburg to Wiesbaden, where he now signs DL9KR. An interesting point is that G6BQ, according to W1BB, is still using his 1930 transmitter—W1BB himself has one unit of Top Band equipment dating back to 1932! His own first Top Band bulletin, back in 1938, says that "average strength of the EU stations was RST 119

G3UCO, hon. secretary of the Cornish Club, operating GB3SMA, Poldhu, on the occasion of the Marconi 70th Anniversary. This was a highly successful effort on the part of the Cornish group, the event having been organised by G3VWK. Contacts were made world-wide, with more than 200 QSO's on 20m. and 576 on Eighty.

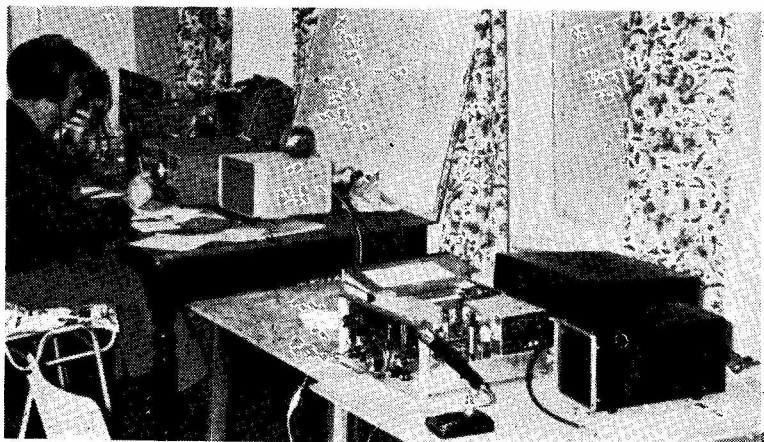

to 229, the G's only in for short periods, with G2PL peaking 339. Known G participants included G2PL, G2DQ, G2IN and G6SQ." (This was during the Trans-Atlantic tests sponsored by SHORT WAVE MAGAZINE, with W1BB's assistance on the American side.—*Editor.*)

G3YMH (Cambridge) managed to get on for the Test from Staines, and to make a dent in the competition, but Ron became—and, indeed remains—a bit hot under the collar over the joker who appeared around midnight on January 29, in the DX channel, calling himself FØLC (phonetic spelling of "false?"). This character was bad enough, but the clots who generated a pile-up on him, burying the DX in the process, come in for even more caustic comment.

After his first taste of success last time round, G3XAP (Stowmarket) decided to try out an inverted-L with sixty feet up and ninety along, which did very nicely until the gales laid it low. Then came

Mark 2, this time, temporarily, forty feet up and 110 feet just drifting, while repairs were made. Now the sixty-foot stick is back up, consisting of forty feet of allii. pole topped by a twenty-foot length of mahogany. The length of the horizontal is—the latest version—to be extended to 130 feet, to get the current antinode further up the aerial. On the feed end there are about 25 radials, some over and some under, the ground. *Phew!*

G3YPT (Swanage) managed a nice 100 QSO's in the Test, and worked a new country in the form of OE—three times, no less! Paul also mentions hearing 8P6DR, *not* coming back to numerous G calls.

Scottish weather was against GM3YOR (Kirkcaldy) who worked the Test with the Glenrothes Club crew, and rolled up about 16K points—it snowed throughout the affair and they were taking the aeriels down at the finish under about six inches of snow!

Contests and Awards

First we have, by courtesy of WIWY of *CQ Magazine*, early results of the 1971 *CQ* WPX SSB contest, where the multi-operator single transmitter category was won by G3WYX, operated by G3HTA, G3RUV, G3RUX and G3TJW. Congratulations—the only G in the results is at the top!

Anywhere from Top to Ten is the rule for the Helvetia 22 effort; the contest runs from 1500 April 16 to 1700z, April 17, and you send RST plus a serial number, receiving RST plus the two letter code for the

Canton. Details from HB9AAA, POB 17, 2500 Bienne 4, Switzerland, to whom also go logs, postmarked not later than thirty days after. The Award is for working the cantons—all 22 of them—and you send the 22 QSL cards to HB9RK, Henri Bullard, POB 384, 1701 Fribourg, Switzerland.

Our old friend the Grafton contest comes up again this month, from 2230 to 0100z on March 18, for AM only, then 2130-0001 on the 25th for CW only, and April 1 at the same times for the SSB leg. Logs, with the usual declaration, postmarked before April 12, to G3KEB, 23 Richmond House, East Street, London SE17-2DU; the detailed rules can be had from G3KEB, for an s.a.e.—Top Band, of course.

A daylight effort is the Chiltern contest, also on Top Band, from 1000 to 1300z, March 5, and for which there are both Tx and SWL sections, with "a small cash token" as prize. Details from G3OGY, 21 St. Margaret's Grove, Great Kingshill, High Wycombe, to whom also the logs should be sent, with declaration.

The White Rose Award is still being issued to applicants, says G3YFP, who finds many people are under the impression it has been terminated. Details of this award, for working Yorkshire stations, can be obtained from G3YFP, 90 Oatland Court, Leeds LS7-1SE.

In this section, we are including details of a DX-pedition: The Nottingham lads, G3TVY, G3VUI, G3YUT and G4AFJ, are going to

COUNTIES TABLE

TOP BAND 1972

| Callsign | Counties CW | Counties Phone | Total Score |
|----------|-------------|----------------|-------------|
| GM3YOR | 51 | 15 | 53 |
| G3YPT | 29 | 5 | 34 |
| G3VLX | 2 | 17 | 19 |
| G3DCS | 14 | — | 14 |

This table will run until December 31, 1972. Starting date, January 1, 1972. Any mode goes.

Andorra, to operate C31FA during April 2-14—in opposition to W4WFL/1 by the looks of it (be interesting if they get together!).

Mobile

The high-powered mobile which W6AM has been organising for himself has been mentioned before in this piece. Don now has it fitted up in the car, and can use it for about an hour each day while doing his normal routine. He finds it to be the best idea in DX'ing since the installation of the rhombics, because the DX tends to call him to discuss DX. He normally starts with a CQ on 14025 kHz, and if that fails to get a bite tries 14008, then around 14090 kHz, CW. Even before the big linear was installed, W6AM/M was up to 176 countries worked during normal driving! Again *Phew!*

Another one who may soon be heard out mobile is ZL2AFZ—we understand from W6AM that George has ordered a DC supply for his TR4, although at the moment he is spending much of his time at the hospital where his wife is recovering from a heart-attack.

The LF Bands

G4ACQ, in the midst of his letter, says quite firmly that *Forty* is his favourite band, despite what the others say, and he hopes to be back on from the new QTH as soon as may be.

G3PTO is another one who likes 7 MHz—he keyed with UA6HBN, EA7JZ, K2PXX, CT3AS, VK3MR and PY2ASY, but was given the cold-shoulder by BYIAS (who appeared to be working only the Eastern bloc countries), FL8MM and VR1AB.

G3NOF looked at both bands; *Eighty* mainly in the mornings, when ZL's have been about, or in the evenings when VE can be found, so that his contacts were with IS0SG, K4CYU, VE1IE, VE1WZ, W1YNP, W3AU and W4BVV. *Forty* was only given a short run, around 0900



Station of G3ZZS, Martin Wills, 148 Churchway, Weston Mill, Plymouth, Devon—he acknowledges the help he had, at his age of 40, from members of the Plymouth Radio Club in getting his licence. His gear consists of Trio TS-510, Heathkit HW-17A, Pye two-metre Tx, Eddystone 940 as main Rx and a Solid-State Modules 2m. converter. His antennae include a TA-33Jr., a trap dipole and an 8-ele Yagi for VHF. The main interest at G3ZZS is DX on 20 metres.

in the ARRL DX contest, finding K1LPL/3, K3HTZ, K9CUY, W1MX, W3AU, W3AZD, W3WJD, W4PCL, W8NGO and WA8JUN. G2NJ (Peterborough) is still "doing his thing" collecting the Maritime mobiles, and this month reports working YO4ASG/MM, on *Forty*, when the m.v. *Braila* was bound for Holland and London.

Only a short list this month from GM3JDR (Wick) who has been rather pushed for time, and, as always happens on such occasions, found that when he could get on, the bands were rather poor. However, the old maestro was not to be denied, and during the morning periods he took the CW scalps of VE7IG/8, VK3ZM, JA0SU, JA1GTF, ZL1AMM, VP9BK, OX5AS, YV5DRN, KL7HBT, VK3MR and all W call areas.

Now to G2HKU (Sheppey) who only gets time these days for very

short sessions, which gave, on *Eighty* CW, CR4BC and OH0MA; and for *Forty* PY7BUS; gotaways on the latter band were FL8HM, YK1OR and VP2AAA.

Forty CW is an interest for W4WFL/1, who made one or two forays on the band and was able to fill his log with assorted Europeans, though nothing new or notable—but the good conditions did allow a bit of ragchewing now and again.

A couple of new ones fell into the 80m. trap set by GM3YOR, these being OY1R on CW and WB0FG /TF on Sideband.

For G4AMJ, CW accounted for W1, W2 and W3, his SSB being used for contacts with VP2VAM, ZL4KE, ZL3RJ, CR4BC, VP2LY, VE1FO and CT2AK.

We turn now to GM3OOK, who is a CW addict, and used that mode all the time, picking up on *Eighty* UH8CS, VP2LY, VP9BK,

To keep in touch with the world of Amateur Radio, read "Short Wave Magazine" regularly—

Independent, Unsubsidised and now in its 30th volume.

W1-4, W8, UD6AM and YNICW. *Forty* was a little more fruitful, with EQ2BQ, FB8XX, JA1BIJ, JA1CWZ, JA4BNT, JA0SU, OD5EJ, PY1DVG, PY6AIQ and UA0AAS.

QSL Addresses

From GM30OK we have ET3USE, via K8IRC; VQ9LW, via 5Z4LW; TA1ST, via JA0CUV; JY6FC, Box 2353, Amman; and CT3AW, via DJ2IB. W4WFL/1 mentions JA3LUX, via WA9TSG,

who also handles cards for YN8AJC and ZL2BIX; cards for VQ9DH, VQ9DM, VQ9DN, VQ9NEW and VQ9W all go to FEBA. Box 234, Mahé, Seychelles, Indian Ocean; EP2BR, via W4BBP. *Ex-DL4WJ* is now back in U.S.A., and cards should be sent to him as W4UVV.

G3NOF has a crop for us; ZD8ES via Radio Club, Ascension Island; KV4DC, Box 3117, Christiansted, St. Croix; 4M5GRA to WA8MAA; VP2VAM to

VE3GMT; XT2AE, to DJ9KR; 9H3B to VE8MR; MP4MBM, to G3ZNN or Box 14, Muscat, Oman; and EL2P to Box 1929, Monrovia.

Signing

Once again we come to the end of the pile of news and reports; our deadline for next month is **March 14** arrival or sooner, addressed as aye to CDXN, SHORT WAVE MAGAZINE, BUCKINGHAM. Hope you like the new style Tables.

SMALL ADVERTISEMENT NOTE

Readers using our Small Advertising columns are reminded that they should get their notices in as early as possible in the month. We have a large carry-over from issue to issue, because so many Advs. come in just too late to catch "the next issue". The minimum charge for a Reader's notice is 50p, which allows 20 words (QTH to be counted in), each additional word costing 2½p. We carry more paid Reader Small Advertising than any other periodical in the field. While we cannot guarantee results, what we do say is that our Small Advertising gives the widest coverage in the U.K.—for this very issue, we had a letter from a reader saying that the last time he advertised in the *Magazine* he sold 90% of what he had offered, whereas a notice in another journal produced only one letter and no sale at all. (We quote this only to substantiate our point about coverage, with which also goes presentation.)

For anything you may want to sell, buy or exchange (and in this we do *not* include what most people would regard as "junk") you cannot go wrong by using our Small Advertisement pages. Notices, with remittance, should be sent to: Small Advertisement Dept., Short Wave Magazine, Ltd., 55 Victoria Street, London, SW1H-0HF. (If you want your notice in **bold face**, like that, add 25%. A Box No. is 12½p extra.)

BACK NUMBERS — Vol. XXIX

Reference the Index in the current issue, we have back numbers of most issues, at 25p post free, *except* those for the months of March, October, November, 1971, and January 1972, these now being out-of-print. If you wish to obtain any available B/N copies write, with remittance, to: Circulation Dept., Short Wave Magazine, Ltd., 55 Victoria Street, London, SW1H-0HF.

QRV AMATEUR RADIO

This is the title of a new, monthly magazine which made its appearance in Germany at the start of the New Year. For those who read German, it is thoroughly to be recommended, since the technical standard is high and the contents range over the whole spectrum of amateur interest. Old Timers may recall that it is now

20 years since the original *QRV* and the German *CQ* were amalgamated into *Das DL-QTC*, the official organ of the DARC—the German Amateur Radio Society—a publication which earned well-deserved respect among the radio amateur fraternity of many countries. But times have changed, and with the change has arisen the requirement for an independent periodical which will not only further the art generally, but which will also reflect the views of the many amateurs whose convictions conflict with the official policy line. Hence the reappearance of *QRV* as a separate entity.

The Editor-Publisher is Felix Koerner, DL1CU, one of the founders of the DARC, and *SHORT WAVE MAGAZINE* wishes him and his colleagues every success in their new venture. Those wishing to subscribe to this new publication should write to Ingeborg Koerner, 7016 Gerlingen, Postfach 9, West Germany, who is responsible for subscriptions and despatch.

ZS PROPAGATION RESEARCH

A recent QSL card from ZS3AW, Tsumeb, South-West Africa, discloses that he is at the Max-Planck Institute out there, concerned with the investigation of "oblique incidence propagation". The path at present being examined is between Lindau in West Germany and Tsumeb. Pulse transmitters and synchronous receivers are used at both ends, ranging across a wide frequency area. The ZS3AW card shows a recording of ionospheric reflection against frequency. ZS3AW himself is DJ7OL when he is at home in Mainz, West Germany.

ELECTRONICS EDUCATION— AMERICAN STYLE

The latest issue of one of the leading American general-interest radio magazines carries advertising by no less than eight institutes specialising in home tuition in Electronics, in all its various branches. Several of these advertisements involve double-page spreads in colour—so there must be money in it for somebody. The theme is, generally, "get qualified for a better job in electronics". It may be that the recession over there of which we hear so much is beginning to recede.

TOP BAND TRANSVERTER FOR TRANSCEIVER OPERATION

GETTING ON 160 METRES FROM
AN SB-101 WITH
FULL TRANSCEIVE FACILITIES

F. POWELL (G3SEL)

WHEN, some two years ago, the writer decided to have a change of equipment the choice was a Heathkit SB-101 Transceiver. Since then he has been delighted with the rig. But as with most things there was one serious snag—it did not cover Top Band.

It was resolved to build a transverter. It has to fulfil several requirements. It must operate transceive; it must derive its power supply from the main rig, and lastly it had to be XYL proof. (The reason for this last is that much operation is from the lounge.)

General Considerations

Looking through the literature a transverter circuit for transmitting only was found in SHORT WAVE MAGAZINE for April, 1971. Talking to a local amateur, he said that he had already built one but this had now been converted to a two-metre transverter. G3CFV explained in detail how he had done this and also how he had converted his SB-101 to provide the necessary drive at low level. These modifications were gratefully incorporated.

Whilst discussing the circuit details G3CFV explained that he did not use an RF stage at all and in fact only one tuned circuit. This meant that he needed an extra valve or two. The proof of his success can be assessed from the fact that he worked W1BB on Top Band many times and also ZL. The use of the extra valves decided the writer to add a few tuned circuits in order to reduce the number to two plus the PA.

The "transmit" side of the circuit is based on the *Magazine* article with a few modifications to suit individual requirements. On the "receive" side the input is fed into the cathode of the RF amplifier. This matched in very nicely and obviated the need for a third tuned circuit operating on Top Band.

The grids of the receiver-mixer and the PA are tuned with a pair of ganged capacitors and take out the IF across a resistor instead of the usual transformer arrangement. (The idea was that the output should remain flat across the band.) This arrangement worked well but the S-meter was not at all lively. It was later changed for a conventional tuned circuit with excellent results. The first idea was to use 7 MHz for the IF and although this did work, there were traces of the large carriers that invade 40m. breaking through.

The next choice of IF was 14 MHz. This worked first time and the "receive" side of the unit is by far the best that the writer has ever heard on Top Band.

Circuit Description

V1 functions as an RF amplifier and receiver mixer. The aerial is coupled into the cathode of the triode section. This keeps the impedance low and with the grounded grid gives very low noise. This arrangement avoids the need for elaborate matching coils and keeps down to a minimum the number of tuned circuits operating on the same frequency.

The output of the RF amp. is fed to the pentode section of V1 (acting as a mixer) via the tuned circuit L1 and the ganged capacitor. The Rx mixer also receives a signal of 12.2 MHz from the CO V2 through the 4 pF feed-through capacitor. The xtal frequency beats with the incoming signal and produces an IF of 14.00-14.20 MHz. (See p.25.)

This IF is selected by the tuned circuit L2 and is fed to the transceiver Ae. socket by the link. The transceiver then operates as a tunable IF and Top Band appears from 14 to 14.2 MHz. Being additive the tuning remains in the correct direction and the sideband is not inverted.

The crystal osc. has rather a high wattage, 47K

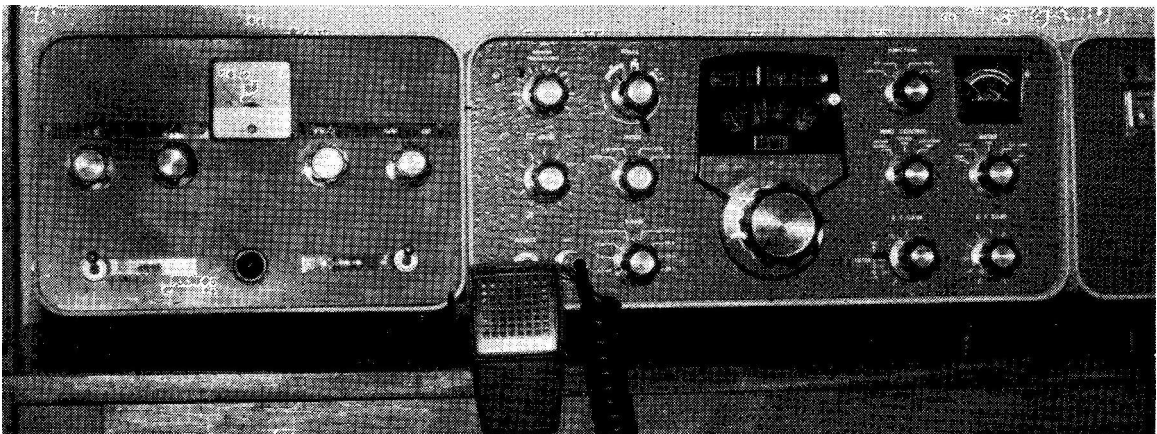

*The G3SEL Top Band Transverter, on left,
works with a Heathkit SB-101 for full
transceiver facilities.*

resistor in the anode circuit; this is required for protection as if the crystal stops oscillating the valve would have no bias and would therefore carry a very heavy current. A 4 pF capacitor is used to feed the transmit mixer V2. The drive for transmit, again 14 to 14.2 MHz is SSB, again lower sideband, is fed across a 75-ohm 1-watt carbon resistor. The series resistor is 680 ohms to provide the correct bias. The drive is applied to the cathode of the mixer V2.

The mixed signal is taken across the anode load and the correct frequency selected by the tuned circuit L4 and the ganged tuning capacitor. Bias for the PA is fed through the RF choke to the grid. No description of the PA is necessary; no screen stabilisation is used except for a large electrolytic capacitor to prevent violent voltage variations at audio rate; this should also have a small (0.01 μ F) capacitor across it because an electrolytic capacitor has considerable inductance at high frequencies.

The screen voltages are removed from the PA and transmit-mixer when on "receive" and the relay used to do this also changes over the aerial.

To get the unit going the ganged capacitor should be set to half-mesh and the transceiver tuned to 1.9 MHz (xtal F + 1.9) on the 14 MHz range. If there is no output try adjusting the coil L3—should this be too far off tune the CO fails to operate. Peak L1 then L2 and L3. Repeat if necessary. The receiver should now cover 160 metres.

Fit a dummy load and go on to "transmit" without drive. Adjust the standing current to 15 mA. Apply drive to the mixer and with the ganged capacitor still at half-mesh peak L4. Reduce drive as necessary and

load and dip the PA.

More than adequate drive is obtainable and care should be taken since with the circuit as shown 90 watts input is possible, which greatly exceeds the legal limit!

Several refinements are possible, such as switching the various inputs and outputs with a single switch to avoid plugging and unplugging each time the transverter is used. If this is done a switch to control the heaters to the transverter should be fitted to disable it when not in use. It could be left on the screen and anode in these conditions without damage.

Construction

This was on a chassis $9\frac{3}{4} \times 9\frac{3}{4} \times 2$ in. which fits nicely into a Heathkit speaker cabinet. The knobs and switches were spaced to be in line with those on the main rig. The front panel is made from aluminium faced with matching green Formica. (This avoided the need to spray the front panel.) *Dymo* tape was used for lettering but I will be replaced one day as it does not really come up to the third requirement!

The whole thing was put together in a couple of evenings. No special precautions were taken in the building except perhaps siting the tuned circuits operating at the same frequency as far away from each other as possible.

All the power was derived from the Heathkit PSU, with the switch which controls the high/low voltage taken out. In its place was fitted a B9A valve holder, paralleled with the main output socket. The PSU itself has a variable bias supply outlet, not used on the SB-101.

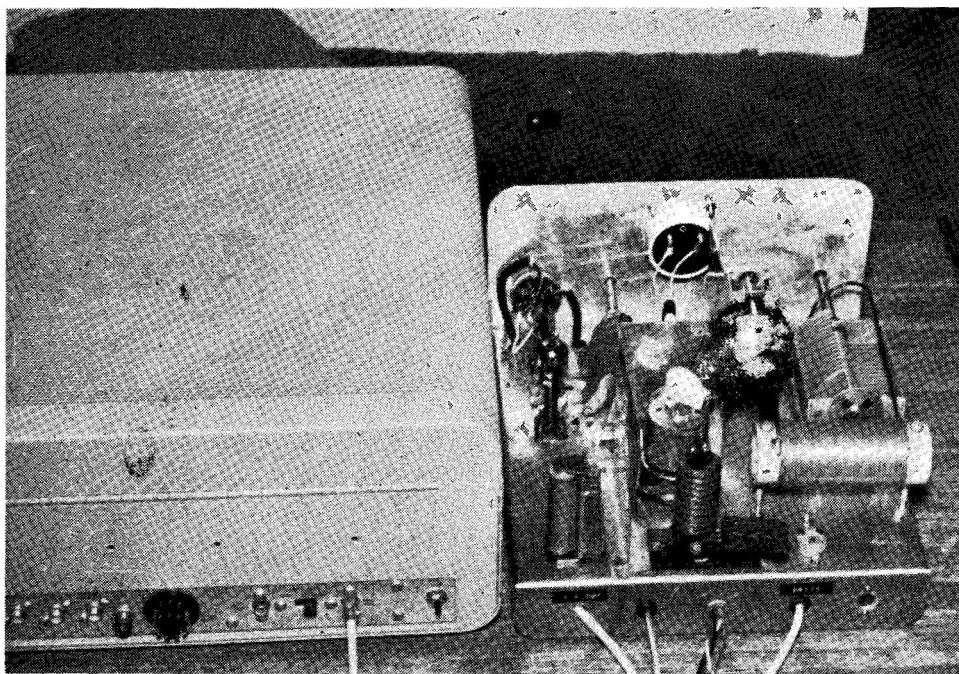

On right, the G3SEL Transverter for 160 Metres.

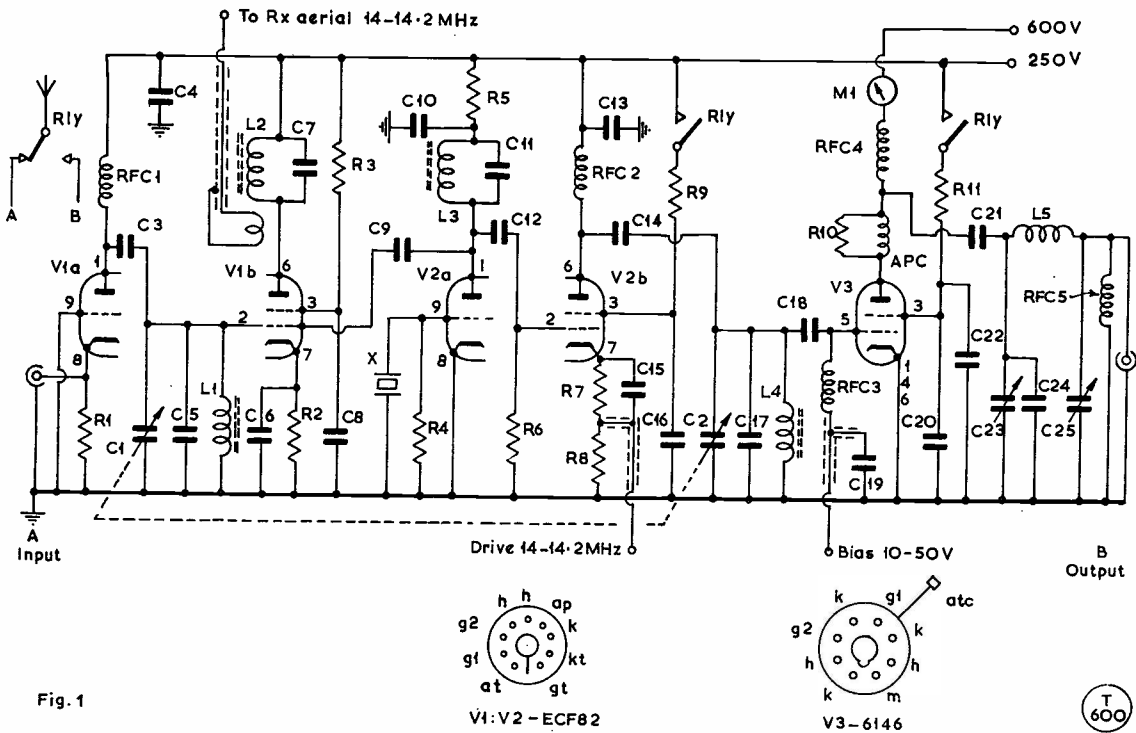

Fig. 1. Circuit complete of the G3SEL Top Band Transverter.

Table of Values

Fig. 1. Circuit of the G3SEL T/B Transverter

| | |
|--|----------------------------|
| C1, C2 = 250 $\mu\mu\text{F}$, ganged | R7 = 680 ohms |
| C3 = .01 μF | R8 = 75 ohms, 1w. |
| C4, C8 = | R9 = 47,000 ohms, 1w. |
| C10, C13, | R10 = 10 ohms |
| C15, C16, | R11 = 10,000 ohms, 1w. |
| C19, C22 = .01 μF | Xtal = see text (12.2 MHz) |
| C5, C17 = 320 $\mu\mu\text{F}$ | Meter = 0-100 mA f.s.d. |
| C6, C14, | APC = Anti-parasitic choke |
| C21 = .001 μF | RFC1- RFC5 = RF chokes |
| C7 = 25 $\mu\mu\text{F}$ | V1, V2 = ECF82, or similar |
| C9, C12 = 4 $\mu\mu\text{F}$ | V3 = 6146, or similar |
| C11 = 56 $\mu\mu\text{F}$ | L1, L4 = 100 turns |
| C18, C24 = 100 $\mu\mu\text{F}$ | L2 = 40 + 10-turn link |
| C20 = 50 μF | L3 = 20 turns |
| C23 = 150 $\mu\mu\text{F}$, var. | L5 = 56 turns |
| C25 = .0015 μF , var. | |
| R1, R2 = 1,000 ohms | |
| R3 = 33,000 ohms | |
| R4, R6 = 47,000 ohms | |
| R5 = 47,000 ohms, 2w. | |

Notes: Coils L1-L4 are wound on $\frac{1}{8}$ in. diameter ex-TV type slugged formers. L1-L4 are wound with 30g. enamel. L5 is of 18g. enam., close-wound, on 1in. dia. former.

This feeds the transverter.

As the PSU gives 12 volts for the heaters, a ballast resistor was needed, as shown in Fig. 4. Incidentally, if a 5B/254M valve PA was used, the heater current equals exactly that of a pair of ECF82's in parallel. This means that the ballast resistor could be left off.

As mentioned the receiver is a delight to operate. Frequency readout is to within 100 cycles. The reports over the air have proved most encouraging, 5-and-9 having been received from all over the country, and quality described as "most excellent".

The photographs show the general layout. The knobs are, left to right, PA Tune, PA Load, Rx and Tx Peak and a switch to disconnect input and output leads. The switches are for the heaters and a coarse load capacitor of .001 μF .

It was intended to stabilise the PA screen voltage but, although it fluctuates alarmingly, it does not seem to degrade the signal. A large electrolytic capacitor, by-passed with .01 μF , would be an improvement.

The only test equipment used was a GDO for the various coils. Incidentally these may not be optimum but they were all taken from old TV sets and they *do* work. Anyone contemplating building this transverter can duplicate these with confidence—several have been made and each one was easily tuned within the slug range.

Some Additional Points

It should be remembered that the usual preselector arrangement on transceivers is also operative when it is used as a tunable IF. The amount of drive required from the transceiver is about 10v. r.m.s. across the cathode load resistor. This is best taken from the main rig driver

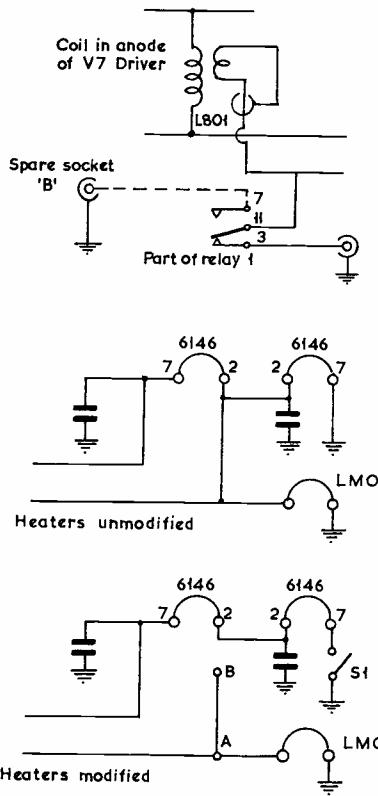

Fig. 2

T 601

Fig. 2. Modifications to the Heathkit SB-101 Transceiver to utilise the G3SEL 160m. transverter. Switch S1 is a miniature toggle, point "A" being taken to pin 2 of the adjacent 6146; this is lifted and joined to point "B" and insulated from earth. Drive is taken from spare point "B" on "transmit," and on "receive" the transverter feeds into the receiver. A screened lead is taken from pin 7 of Relay 1 to spare "B" (this pin has no previous connection). In operation, the heaters are open-circuit to disable the PA.

and disabling the main PA by just switching out the heaters. (For the fortunate ones owning an SB-101 this is very easy indeed, as seen from Fig. 2 above.)

It is obvious that any frequency of crystal could be used between 12.2 and 12.35 MHz. If the transceiver covers 14.00 to 14.50 MHz, as most do, then the xtal could be as high as 12.5 MHz.

If a xtal frequency on a 100 kHz point is chosen, then frequency readout is simple. The choice of 12.00 MHz plus allows the transceiver to be used on the sideband indicated. No inversion takes place. The receiver tunes in the correct direction with a transceiver *automatically* changing sideband on the HF bands then a different crystal frequency must be used or the sideband inverted.

The diagram Fig. 2 shows the SB-101 heater wiring. The earthy end of the heaters is taken to chassis via a miniature toggle switch which fits into a hole already bored adjacent to the heaters. The connection to pin 7 from the LMO valve heater is lifted and joined as shown. A connection is taken from pin 7 on relay No. 1

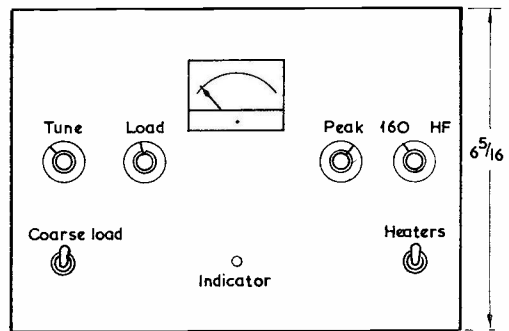
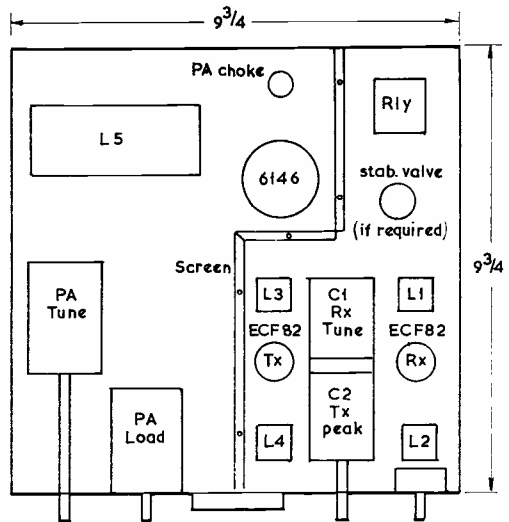

Fig. 3

T 602

Fig. 3. General layout diagrams for the G3SEL Top Band Transverter as described in his article. The front panel is aluminium-faced—see photographs. The chassis is 2in. deep and fits a Heathkit speaker enclosure.

to a spare outlet socket on the rear of the '101. This should be screened and earthed at the socket only. This lead now carries the drive to the converter.

The IF outlet from the transverter is taken to the Ae. socket or to the spare receiver socket on the transceiver.

A relay was used to remove the voltages on the screens of the transverter PA and transmit-mixer. This relay also changes over the aerial.

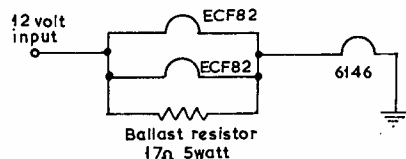

Fig. 4

T 603

Fig. 4. Heater arrangement for the Transverter when using a 12-volt LT supply—see text.

USING THE ROLLER COASTER COIL UNIT

CONTINUOUSLY VARIABLE INDUCTOR FOR AERIAL WORK

F. G. RAYER, A.I.E.R.E. (G3OGR)

THERE have been on the surplus market for some time very robust and excellently made roller coaster variable inductances, and some details on their use for aerial loading should prove of interest. The type in mind has some 48 turns of silver-plated wire on a former about 2½ in. in diameter and 7 in. long. A roller bears on the coil, which can be rotated by a ¼ in. diameter spindle. It is thus possible to bring into circuit any required number of turns, or a fractional part of a turn—see picture.

End-Fed Wires

This device is particularly intended for an end-fed aerial. It is not proposed to discuss the relative merits or demerits of end-fed wires here, but it is generally known that *any* length of end-fed wire can be used on *any* band, provided some means of matching can be arranged, so that the Tx is loaded. (It might perhaps be added that

longer wires will generally radiate better than shorter, and that though local stations can often be worked with a few feet or wire, it is better to put up a more conventional length.)

Fig. 1 is the simplest way of using the roller coaster. The SWR indicator and coax can be 75 ohms, or as preferred, and continues to the coaster on the assumption that the wanted 75 ohms will indeed exist here.

The roller coaster is set so that no turns are in circuit, and the transmitter tuned to produce some RF, while monitoring reflected power on the SWR meter. The coil is then rotated to bring into circuit such inductance as results in the lowest SWR. This could well be near 1 : 1. (See p.28.)

With a simpler set of equipment such as a small AM/CW Tx and no SWR indicator, merely bring into circuit the number of turns which allows the PA to be loaded. The roller coaster can be put at any convenient point in the aerial lead.

Adding a Capacitor

The roller coaster adds inductance, so works readily with those aerials which are short in terms of a ½-wave (or multiple). Where the aerial is long in terms of a ½-wave (or multiple) adding extra inductance may be unsatisfactory. This is shown by the SWR staying high, despite full adjustment of the roller coaster.

The circuit can then be modified by connecting a transmitting type variable capacitor of about 200 pF

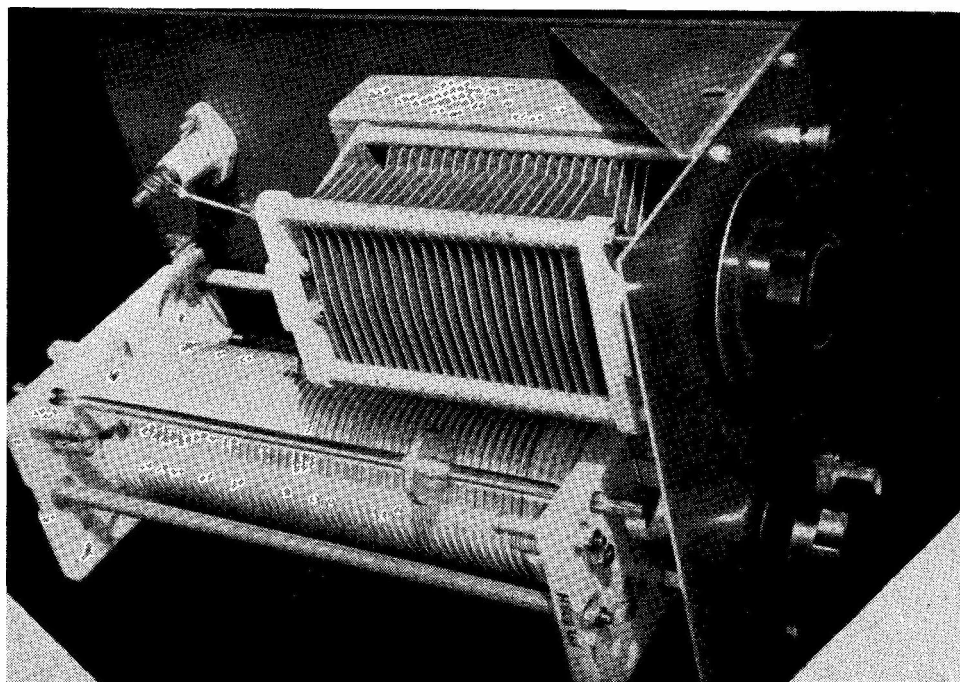

The metal panel carries a coax socket and earthing terminal. The coil is rotated by an insulated coupler and shaft running in a panel bush. The condenser is a wide-spaced Tx type of 300 pF and the stand-off insulator is for the aerial connection. These excellent roller-coaster inductors, infinitely variable through the whole range of the coil, were found in the old Wilcox-Gay master oscillator unit, of which there must be many still extant.

to 350 pF from A, Fig. 1, to earth, and to the outer conductor of the coaxial cable, as in Fig. 2. (This is the arrangement adopted in the unit in the photograph.)

Both the capacitor and roller coaster are then adjusted for the lowest SWR, starting with minimum capacitance and inductance settings. It may be found the SWR can be made very near 1 : 1, Top Band to 10m.

If an aerial proves tricky on one or two bands, it may be worth changing its length a little. With a longish wire, one setting may do for a whole band; with an aerial on the short side, readjustment may be necessary when moving frequency within a single band. It is worth noting the number of turns and capacitor setting, for each band, as the whole system can then be set up mediately for any band, as required.

Other Methods

The roller coaster could be placed at the foot of a vertical, or part way up a vertical, and adjusted in the usual way when operating with a vertical whip.

It could also be used experimentally as a fully adjustable *pi*-tank or matching *pi* circuit, by employing two variable capacitors.

Mechanical Details

The unit illustrated was built on a wooden base 10½ in. x 7 in. with a metal panel 7 in. x 5 in. supported with two brackets. This was to reduce hand capacity effects. An insulated flexible coupling connects a ¼ in. shaft, which runs in a bush fixed to the panel. A coax socket on the panel takes the plug and coax from the Tx or SWR indicator, and an insulated terminal near the back is for the aerial lead.

Aerial Length

It is often felt that an end-fed aerial ought to be some particular length, and typical lengths, such as 67 feet or 135 feet, are often quoted in literature on aeriels. A particular length may have some known characteristic, such as being a multiple of half-waves. As example, 135ft. is near one ½-wave on 80, and a multiple of ½-waves on all higher frequency bands, so would thus be high-impedance at the feed point, and could be fed from a parallel tuned circuit. In the same way, 67ft. could be parallel fed on all bands 40-10m. The 67ft. would be low-impedance, however, on 80m. and thus require series tuning, just as the 135ft. would need series tuning on 160m. for the same reason (e.g., as a ¼-wave).

Apart from these considerations of arranging to feed a roughly known impedance, the writer has never been able to find any justification in terms of signal strength for choosing a particular length. Provided the aerial is fed so that it loads the transmitter correctly, measurements have never given the slightest evidence that there is some "correct" (or resonant) length which is best. Taking, as example, 130ft. as a ½-wave at 3.6 MHz, varying this length from something clearly too short, up through the correct length to something manifestly too long (say from 115ft. to 145ft.) has not been found to give a peak in signal strength at about the estimated ½-wave length, or at any other length. (This is in accordance with known fact, forgotten nowadays, that you can make an old bedstead radiate if you can bring it to

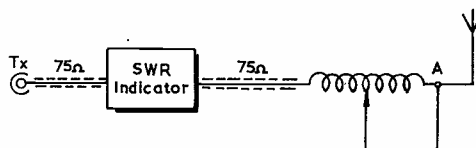

Fig. 1 Use of 'Roller-coaster' alone

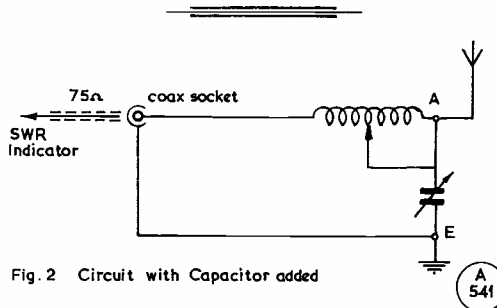

Fig. 2 Circuit with Capacitor added

resonance. Editor.)

It would thus seem that in the present case an end-fed aerial really can be a "random" length.

It ought to be added that these comments on length apply only to the use of an end-fed wire, and such a wire employed with some efficient means of feeding it. The remarks do *not* apply to coax fed dipoles, or other aeriels where the length can in fact be extremely important. Nor is it meant to say that a short aerial is as good as a long aerial, but only that no "correct" or resonant length appears to be necessary, where a change of a few feet one way or the other will profoundly change radiation efficiency.

Long wires will of course have various directional effects, with lobes which can show gain over a dipole. A "long wire" is actually one which is a multiple of ½-waves, or substantially longer than a ½-wave. Thus about 135ft. would be a "long wire" on the HF bands, but not on 80m.

RACAL RADIO CLUB SALE

The next G3RAC sale—the last was in June '71—of really good ex-factory parts, equipments and material, will be held on Saturday, March 25, 2.0-5.0 p.m., at St. Sebastian's Hall, Nine Mile Ride, Crowthorne, Berks., the Ride running E-W just south of Wokingham, between the A.321 and A.3099. St. Sebastian's Hall is on a cross-road, and there is ample parking. The gear on sale will be offered "as seen" at modest prices, as the objective is to clear the lot. No liability will be accepted for the condition of items on sale, though Racal Club members will do their best to give advice. This sale is for the genuine D-I-Y man and one-off buyer. Be it noted that trade and bulk buyers (the "I'll take the lot" types) will be actively discouraged.

THE PHASE-LOCKED LOOP

DISCUSSING SOME PRACTICAL APPLICATIONS OF A MODERN IC DEVICE

J. M. OSBORNE, M.A. (G3HMO)

For years, John Osborne has been contributing articles to SHORT WAVE MAGAZINE dealing with what might be called the more esoteric aspects of radio amateur interest—from the home-construction of transistors (in their early days) and sunlight-powered transmitters and receivers using photo-electric cells, to new thoughts about mobile Tx and aerial design. He also contributed a series of articles, as long ago as 1954, on the general subject of Transistors

—mainly, these were far in advance of their time. Then came radio astronomy in the amateur context—for example, the Stowe Radio Telescope, in 1958, which inspired much practical interest in that subject. Latterly, G3HMO has been interested in getting pictures from Wx satellites, and some of his results in this field have already been covered in the Magazine. Here, he brings his researches up-to-date in describing what for many readers will be something entirely new in the application of IC devices.—Editor.

THE Phase Locked Loop (PLL) is an electronic technique known for many years, although its complexity precluded its wide usage. Its versatility is only now becoming apparent since it has become available as an integrated circuit on a single chip. The NE-561 described here has some 25 transistors on the chip. Since the PLL makes an ideal FM discriminator, this application will be used to explain the basic principle.

The essential components of the PLL are a voltage controlled oscillator (VCO) and a phase comparator. The VCO frequency varies linearly with the control voltage; the phase comparator output is proportional to the difference in phase between two input signals. They are connected as shown in Fig. 1. The VCO has its free-running frequency adjusted to approximately that of the FM signal. The two signals are compared in the phase comparator, the output of which, suitably amplified, is used to control the frequency of the VCO. It is connected in such a sense that it reduces the phase difference until it is finally zero. So, provided the difference in frequency is not too great to start with, the VCO locks on to the incoming signal—hence the term “Phase Lock Loop”.

Advantages

The fact that we have a strong local oscillator running at exactly the signal frequency is of great interest in many applications. However, for the moment, consider the

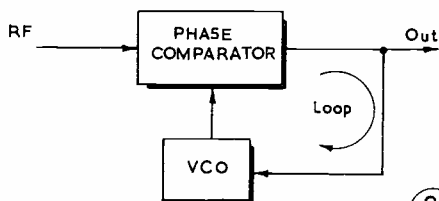

Fig. 1

Fig. 1. The basis of the Phase-Locked Loop—see text.

phase comparator output when the input signal is frequency-modulated; the voltage out goes up and down to keep the VCO locked on. The voltage out follows the FM and so in effect it is the audio output.

Some attractive features of the system are: That the audio voltage depends only on the frequency deviation; that this can be highly linear for Hi-Fi; that it is independent of signal amplitude; that it largely ignores noise; that drift problems cease as the PLL locks on; that tuned circuits (and alignment procedures) almost disappear.

The VCO is a four-transistor RC oscillator the frequency of which is linearly dependent on the control voltage. It requires an external capacitor to set the frequency; fine tuning is accomplished by a resistor and potentiometer, as shown in Fig. 2. No coil or variable capacitor are needed.

The basic circuit of the comparator is shown in Fig. 3. It consists of six transistors; two connected as a long-tail-pair divide the current between two other pairs, with common push-pull input and parallel output. In integrated circuits, where the number of transistors is no limitation, this is an obvious choice of circuit for product detector, multiplier or balanced modulator. The comparator output is conditioned as shown in Fig. 2. Noise in the RF input would produce sudden jumps in the

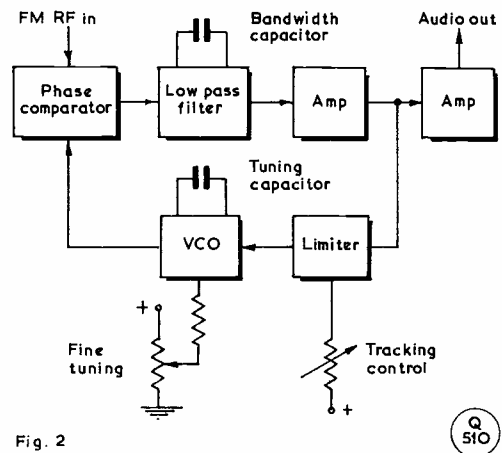

Fig. 2

Fig. 2. The main stages in the NE-561B IC, showing essential external components. Stages relevant to AM demodulation, not discussed in this article, have been omitted.



Mosaic made up from a number of photographs received from ATS-3 after the PLL was fitted—note the complete absence of the interference effects shown in another picture. Here, the middle lower section shows the Pacific coast of South America. At bottom right is the northern part of S. America. The dark patch at top left is night-time out on the West coast of the United States.

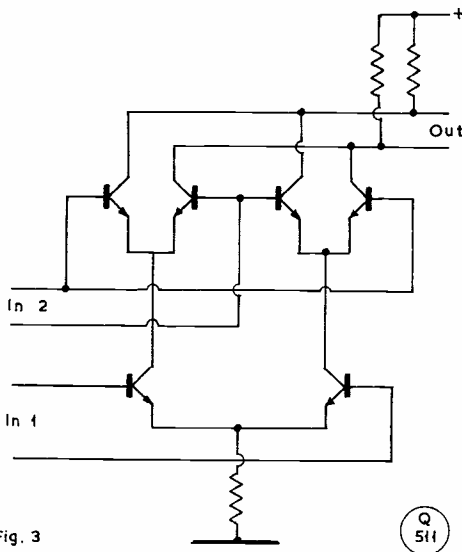

Fig. 3

Fig. 3. The basic comparator circuit. This can be used either to compare phase relation; multiply as in a product detector; or as a balanced modulator.

comparator output, hence noise in the audio and sudden jumps in the VCO frequency. On the other hand, frequency modulation does not normally cause discontinuous jumps. The fastest change of frequency depends on the deviation (modulation index) and highest modulation frequency. The low-pass filter sets the maximum rate at which the comparator can shift the VCO frequency. If the frequency shifts faster than the limit set by the filter, lock is temporarily lost. In other words, a noise spike throws the lock off but the VCO frequency remains momentarily unchanged. The filter capacitor provides a short-term "memory" of the last locked frequency so that, after a noise pulse, the loop

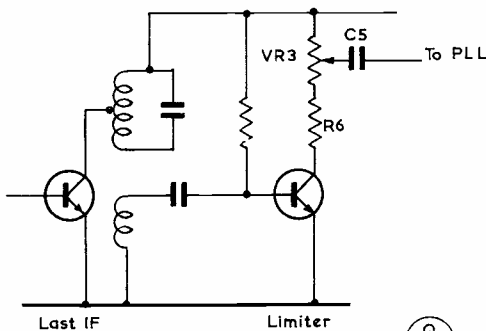

Fig. 4

Fig. 4. The limiter stages after modifications to a commercial 460 kHz IF strip with the original FM discriminator removed.

regains lock as though nothing had happened. This means that there was no audio output due to the noise pulse.

This simplified account does indicate how effective the PLL is at resolving weak signals in noisy conditions. In effect, the filter sets the bandwidth and the "Capture Range." The capture range is how far off the free-running frequency of the VCO the signal can be and still pull the loop into lock when the signal is applied.

The control voltage from the amplifier passes through a limiter. The limiter determines how far off the free-running frequency the VCO can be driven by limiting the control voltage that can be applied to change the VCO frequency. This determines what is known as the "Tracking Range". This is how far the VCO can track the frequency of a signal to which it is locked before losing lock. A variable resistor enables the tracking range to be adjusted. The smaller the tracking range, the greater the selectivity in the sense that adjacent channel signals cannot be pulled into lock in place of the wanted signal. However, the tracking range must allow for deviation due to modulation and drift, such as is caused by Doppler shift in satellite reception.

Some Circuitry

In an experimental circuit to test the feasibility of the PLL, the discriminator was replaced in a broadband 460 kHz IF strip designed for NBFM by a Signetics Corporation NE-561B.

The chip will work above 15 MHz and is also suitable

Table of Values

Figs. 4 & 5. The Limiter Stage and NE-561B Wiring

- C1 = 1 μ F
- C2 = 650 μ μ F
- C3, C5 = .01 μ F
- C4 = 500 μ μ F to .01 μ F (see text)
- R1 = 15,000 ohms
- R2, R6 = 10,000 ohms
- R3 = 2,000 ohms
- R4, R5 = 47 ohms
- VR1 = 50K potentiometer
- VR2 = 10K potentiometer
- VR3 = 50-ohm pot.
- IC = NE-561B phase-locked loop, Signetics Corp.

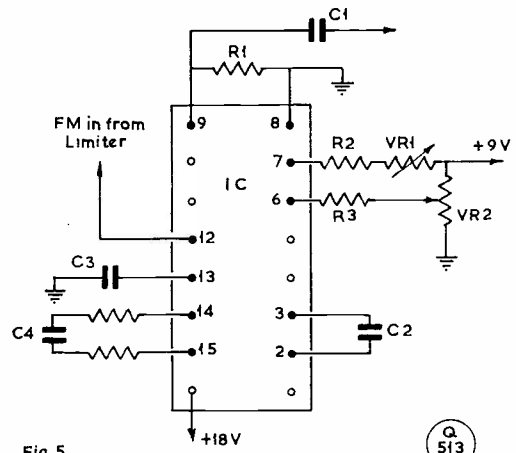
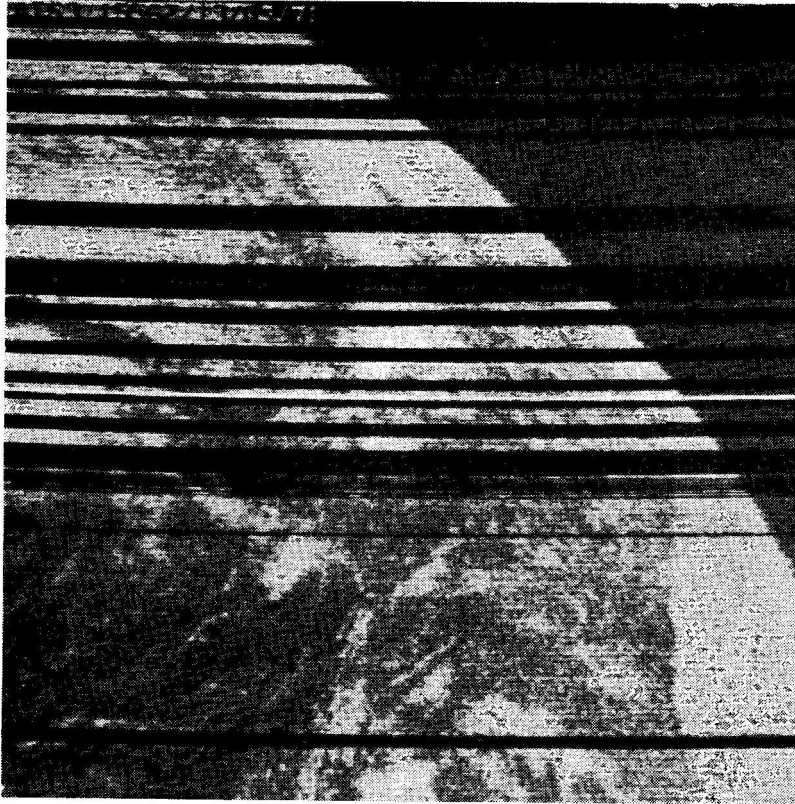

Fig. 5

Fig. 5. Practical wiring round the NE-561B IC chip, showing pin connections when used as an FM demodulator. Note: R4, R5 are connected to C4.



An ATS-3 picture showing a segment of the earth below. The bars are caused by adjacent-channel QRM from aircraft. This picture was recorded before the PLL was in use—compare with larger photograph on p.30.

for a 10.7 MHz phase-lock loop. The sensitivity is very high and the loop locks on to the "smell of RF." In fact, the signal input should be limited to about 10 mV and this particular strip had far more gain than needed. In the first lash-up, the PLL was fed from what was thought to be a tap on an earlier IF transformer, as it indicated a few millivolts when the strip was tested with a signal generator and CRO. The results were disappointing, for although the loop locked to the input (a weather satellite) the noise was bad. Further investigation revealed that the loop was locking on to stray RF at a point that was intended as an earth connection! It was remarkable that one got any results at all.

The limiter stage of the strip was then revamped, as shown in Fig. 4. The tuned circuit in the collector circuit of the transistor was replaced by a high resistance so that the transistor saturated on even a weak signal, the output amplitude being about battery voltage. Of this, about 10 mV was tapped off a 50-ohm pot., as shown in the diagram. The very low resistance has the advantage of virtually shorting the PLL input to any stray pick-up. There is no advantage in using a larger input, as this only degrades the AM rejection. At 10 mV this is excellent and it is possible to lock on to a strong AM station and hear silence.

The wiring around the PLL is shown in Fig. 5. The original battery supply to the strip of 9v. was used for the tracking and fine tuning and an extra 9v. battery added to provide 18v. at about 10 mA for the integrated circuit. C2 was made up to the right value from silvermica's in parallel to make the free-running VCO frequency about 460 kHz. The internal bias conditions require that one side of the RF input be grounded through C3 and the AF be brought out with R1 and C1, as shown. R4 and R5 form a 100-ohm optional part of the low-pass filter, split only for convenience and symmetry. C4 can have typical values from say 500 pF to .01 μ F to vary the bandwidth. In practice, one of six values can be selected by a switch, though for simplicity this is not shown on the diagram.

The main purpose of the complete receiver is to receive satellites and in particular *ATS3*, a geo-stationary satellite over South America, on 135.6 MHz, in spite of strong adjacent-channel interference from nearby air-aircraft. Results in practice are excellent, whereas previously with the conventional FM discriminator it was the exception to get a complete picture from the satellite unspoilt by aircraft QRM. The receiving line up is shown in Fig. 6. The aerial is a *J-Beam 2/10Y*, a ten-element Yagi cut for the band. The plane of the

aerial is rotated, by cord from the ground, for maximum signal. The aerial feeds an SSM preamplifier and SSM converter, both peaked on the frequency. The IF is tuned by the front end of an EC-10 Rx (19.6 MHz). The (2nd) IF from the EC-10 mixer is brought out to the strip already described. The audio, typically about 100 mV, is returned to the EC-10 audio input which has been disconnected from the internal AM diode detector of the EC-10. The audio output drives both an internal monitor speaker and the line to the picture-making apparatus. The EC-10 internal IF (narrow band for AM) and the diode detector are used to drive an external S-meter as well as to provide AGC.

Operation

The sensation of operating a PLL receiver is very strange. If one changes the PLL fine tuning or swings the main receiver substantially off tune, while picking up a signal, the signal comes through at just the same strength. It feels like half-a-turn or more of backlash on the tuning knob. It is difficult to know how to optimise the receiver controls under these conditions. The procedure adopted is (a) To set the main receiver tuning for maximum S-meter reading (this can be effected by FM taking the carrier partly out of the bandpass of the IF but is not critical); (b) Swing the fine tuning both ways until the lock is lost and set approximately mid-

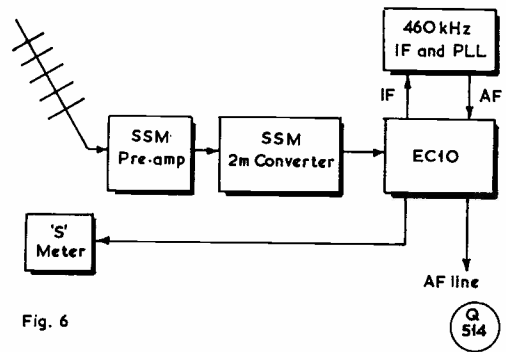

Fig. 6

Fig. 6. Equipment arrangement as at present in use at Westminster School, London, for receiving weather satellites, including ATS-3, the geo-stationary body over South America. The preamplifier and two-metre converter are by Solid State Modules. The main receiver, for the tuned IF, is an Eddystone EC-10. The external IF strip and PLL NE-561B are combined as an outboard unit with the Rx—see photograph below. The aerial is a J-Beam Type 2/10Y, a 10-ele Yagi, adjusted for the working frequency at 135.6 MHz, on which ATS-3 transmits.

(cont'd. over



The PLL unit, as used by G3HMO and discussed in the article, is in a chassis which sits on the EC-10 main Rx. Controls are explained in the text, except that the small central unmarked switch selects a range of capacitors for varying the bandwidth of the LFF.

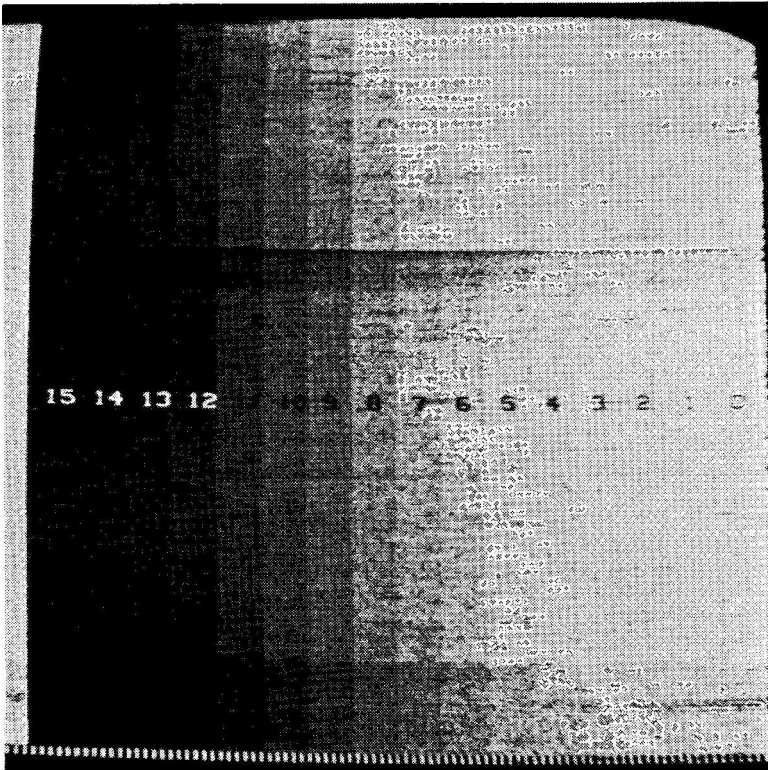

The Gray Scale sent by weather satellite ATS-3 as a test card.

way; (c) Decrease the tracking resistance until the signal drops suddenly and then turn the control back 10° or so; and finally (d) Set the low-pass filter capacitor to the maximum consistent with not losing the higher audio frequencies. Easy, non-critical—but very unfamiliar!

While we shall hear more of the PLL in the future,

e.g. broadcast receivers with no tuned circuits, the immediate amateur possibilities are for NBFM on all bands and for FSK and RTTY applications. The particular IC used here, unlike most others PLL's, has AM demodulation facilities. This requires a fairly involved theoretical explanation to be given at another time.

MOBILE RALLY FIXTURES

Further to the note on p.727 of the February issue of SHORT WAVE MAGAZINE, following are the Rally dates which have been notified to us.

- April 2:** White Rose Mobile Rally at Lawnswood High School, Leeds, 6. Full information from R. Short, G3YEE, Bradford 664220, or E. Lawley, G8EHV, QTHR.
- April 16:** North Midlands Mobile Rally, Drayton Park, Tamworth, Staffs.
- May 7:** Spalding Tulip-Time Tally, at Surfleet, near Spalding, on the A.6. Details from R. Harrison, G3VPR, QTHR.
- May 21:** Annual Northern Mobile Rally, at Moor Grange School, Parkstone Avenue, West Park, Leeds, as last year. Information: D. Binns, G3MGI, QTHR.
- May 28:** Chiltern Amateur Radio Club Rally at West

Wycombe, Bucks., at the Dashwood home near High Wycombe. To coincide with the Steam Rally and the Model World. Details from: P. Perkins, G3OUV, Loakes House, Loakes Park, High Wycombe, Bucks.

June 18: Anglian Mobile Rally, at the Suffolk Show Ground, Ipswich. Contact: D. W. Thomas, G3LZN, QTHR.

July 16: Upton-on-Severn Mobile Rally organised by the Worcester & District Amateur Radio Club. Information: B. Jones, G8ASO, QTHR.

August 13: Torbay Amateur Radio Society Mobile Rally at Newton Abbot Rugby Ground.

August 13: Annual Derby Mobile Rally at Rykneild Schools, as in previous years. Details from: T. Darn, G3FGY, QTHR.

Organisers are asked to let us have relevant details as soon as possible, addressed: "Mobile Rally", SHORT WAVE MAGAZINE, BUCKINGHAM.

LOADING UP A WIRE FOR TOP BAND

SUGGESTIONS FOR LIMITED SPACES

J. S. CUSHING (G3KHC)

AN end-loaded aerial for Top Band may take the form shown in Fig. 1, where 40 or 50 feet of wire is run out in an inverted-L formation, with a loading coil placed at the far end of the wire. The coil functions so that the aerial is lengthened to rather more than a half-wave, causing high current to flow in the vertical and top sections, so ensuring good radiation from an apparently short aerial. Approximate data for Fig. 1 are an inverted-L of 40 to 50 feet of wire, joined to a *non-inductive* loading coil made from about 110 feet of wire. (Strictly, the coil as described later *will* have inductance, but it will be low enough to be termed non-inductive.) The Tx will then, because the coil is virtually non-inductive, "see" an aerial equal to a physical length of 150-160ft.

Before describing how to determine exactly the length of wire used and how to construct the loading coil, it may be helpful to run over current distribution in lengths of aerial typical of 160 metres. For convenience, diagrams show aeriels as straight lines—in practise an inverted-L formation would be used.

No attempt is made to go into deep theory discussing these aeriels, but if the reader wishes to check any point, one of the usual *Handbooks* should answer most queries. (On the other hand, if the theory seems a little difficult it is of no great importance). A perfectly good aerial can be built so long as the design procedure given here is carefully followed.

Looking at Fig. 2A, a half-wave, it will be seen that maximum current (the current antinode) is 130ft. from the free end and at this end current is low, but voltage high.

In the case of Fig. 2B, maximum current is still 130ft. from the free end and at this end current is low but voltage high.

Fig. 2C, a quarter-wave, also shows maximum current 130ft. from the free end, and once more current is low at the free end where voltage is high.

Considering Fig. 2D, free-end conditions are again

low current and high voltage. But the point of maximum current occurs at the Tx end; the current at this point will be rather less than maximum current indicated in Figs. 2A, 2B and 2C.

Three conclusions can be drawn from the foregoing:

- (1) The free end of the wire is always a high-voltage low-current point,
- (2) Maximum current is developed 130ft. from the free end. (So long as the effective length of the aerial is 130ft. or more),
- (3) If the aerial is a quarter-wave, or a little more, most radiation comes from the first 50 or 60 feet nearest the Tx, for in this part most current flows. It follows that the

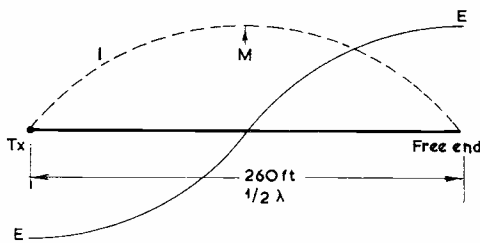

Fig. 2A

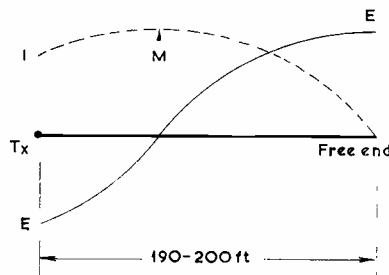

Fig. 2B

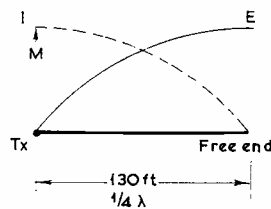
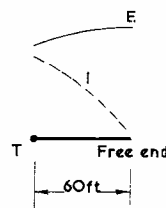

Fig. 2C



E = Voltage curve
I = Current curve
M = Max. current peak
(current antinode)

Fig. 2D

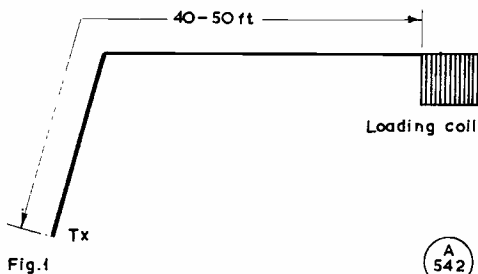

Fig. 1

A 453

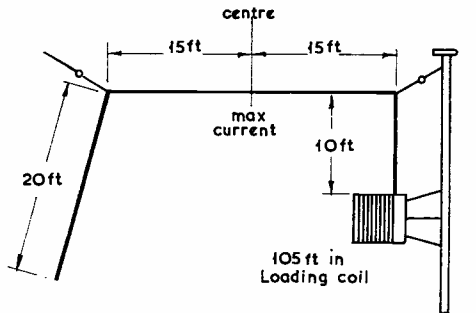

Fig. 3

A 544

Frame about 3 x 3ft (or as convenient) of 2 x 1 inch timber

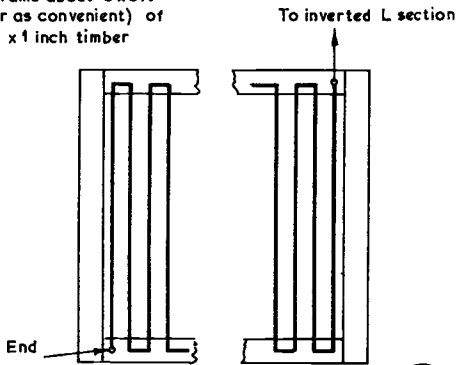

Fig. 4

A 545

part of the aerial carrying low current—the length towards the free end—puts out very little signal.

The aerial evolved, with a 20ft. vertical and 30ft. top, is illustrated in Fig. 3. It was designed as follows:

- (1) A rough sketch like Fig. 3 was drawn,
- (2) Measurements were inserted in the sketch,
- (3) The distance from the centre of the top to the start of the loading coil was now known to be 25ft. minus 15ft. plus 10ft. down lead to loading coil,
- (4) This length of 25ft. subtracted from 130ft. gives an answer of 105ft., which is the length of wire to be made into a loading coil.

Practical Approach

Anyone intending to try this scheme need not attempt a "Chinese copy" of Fig. 3. It is only necessary to follow the four steps just outlined to tailor an aerial to fit in whatever space is available.

The following points should be kept in mind: Maximum current should be arranged to occur at or near centre of the horizontal top because most radiation will take place from this section which will be the highest part of the system. The loading coil is placed down the

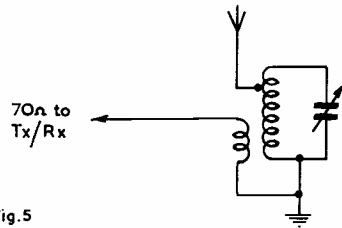

Fig. 5

A 546

mast and being large it is easier to mount it a little above ground level. This necessitates using a down lead, the length of which is not important. (Note: Sufficient RF voltage will be present on the loading coil to give an unpleasant tingle, so if young children are about see it is not within their reach.) Also unimportant is the length of top and vertical sections. The vertical section could be a few feet only, or even omitted if an upstairs shack is used.

The Loading Coil

The manner in which the loading coil is made determines to a large extent how well the system works. It is essential to wind non-inductively, or perhaps more correctly, wind to result in very low inductance. Fig. 4 shows how this is done, the wire being run to and fro across a frame with a spacing of about one inch between turns. This spacing is not critical in the sense that it must be one inch, but rather in the sense that if spacing is increased the frame tends to become large and unwieldy; if spacing is decreased some self-capacitance and inductance will be introduced which may affect current distribution in the inverted-L section. A frame can be made from 2-by-1 inch timber and if a 3-by-3ft. square is used about 100ft. of wire can be accommodated. Ideally, wood or plastic pegs should be fitted into the 2-by-1 timber but for a lash-up, insulated staples will do. Two further practical details need mentioning: One is to use the same gauge or type of wire, if multistranded, for the whole system. Secondly, the loading coil does not have to be square; a rectangular shape is quite as satisfactory.

If the transmitter is *pi*-tuned it will probably load quite happily into this aerial system, but if an ATU is used a simple parallel tuned type, as shown in Fig. 5, should do well. The aerial is current- rather than voltage-fed, so it will be tapped well down the coil. Adjustment is best carried out with a SWR bridge.

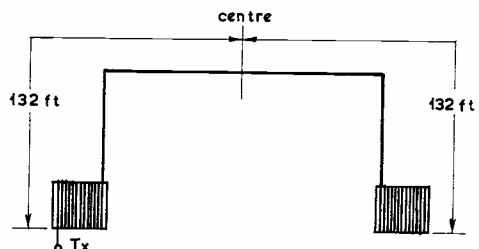

Fig. 6

A 547

Earthing

As the aerial is current-fed it follows current to earth will be appreciable so that a good earth system is desirable. A method of reducing earth current is to try using about 260ft. of wire arranged as outlined in Fig. 6. The length of wire is about a half-wave on 160 metres and Fig. 2A shows low current at the Tx end, therefore current to earth will not be at all high so earth losses will be lower. Use of a half-wave will mean the ATU tap will be towards the top of the coil.

If a loft is the only place to put an aerial, end-loading 15 to 20ft. with 120ft. should result in a compact system suitable for local matters. Such an arrangement has been briefly tried and found satisfactory.

Results

Results obtained with the outdoor aerial have, in view of its small size, been encouraging. But it must not be forgotten that a compact aerial of this type can produce very odd radiation patterns which may give rise to doubts about its efficiency. Any assessment based on a couple of evenings' use could be very misleading, so a lengthy trial period is suggested.

The author's aerial gives ground-wave QSO's up to 20 miles. Sky-wave working depends on the time of day or night as well as period of the year. A few daytime contacts have been made at 50 to 100 miles' distance. Range after dark improves considerably and stations at 100 to 400 miles away have been worked without difficulty. The most distant, at 400 miles, reported R5 and S9, which suggests the system is a practical proposition, worth trying by anyone with limited space.

MATTERS OF MOMENT

Your copy of this issue should include, as a free loose supplement, the Index to Vol. XXIX, which concluded with the February, 1972, issue. We now embark on Vol. XXX—rather wondering how we've got thus far! To keep your 12 issues of Vol. XXIX together, get yourself an *Easibinder*, 88p post free from our Publications Dept., which makes an easy job of it.

* * *

On January 7 last, at a social occasion in London, Tim Hughes, G3GVV, was installed as this year's president of the RSGB. He is an academic, being head of the dept. of technology at Tonbridge, the well-known public school. A major in the Territorial Army, he holds the distinction of TD, and is also DLC.

* * *

Reference the article on a Digital AFSK Oscillator in our January issue, the values for the PSU on p.675 are incorporated in the table on p.671—several readers appear to have missed this.

* * *

The latest R.A.I.B.C. list shows that they now have a total of about 400 members. Of these, some 155 hold full transmitting licences. All are either blind or otherwise more or less totally incapacitated. The hon. secretary of the Radio Amateur Invalid & Bedfast Club is Mrs. Frances Woolley, G3LWY, Woodclose, Penselwood,

Wincanton, Somerset—who herself has to keep fit and well to deal with her far-flung flock. Hers is very much a labour-of-love and she is always glad of assistance, particularly with visiting.

* * *

In some recent advertising in the public print, firms offering receivers capable of tuning to the shipping, police, aircraft and other service bands include a notice to the effect that "a licence, not normally available to the general public, is required from the MinPostTel" if these sets are to be so used. In other words, the official ruling about listening outside the amateur and BC bands is just as we stated it on p.431 of the September issue of *SHORT WAVE MAGAZINE*—except that unless you can show good cause, the Ministry will not anyway issue a receiving licence in this category. (We would think that "good cause" could be for the reception of satellite signals for experimental purposes.) Further correspondence should be addressed to the Ministry of Posts & Telecommunications, and *not* to us!

* * *

With reference to the photograph and caption on p.731 of the February issue, we are informed that the machine illustrated has not been found entirely satisfactory in commercial service. On the other hand, it could still be of interest in the purely amateur context.

* * *

The *CHARN Fund*, instituted to provide amateur-band receivers for Cheshire Homes, was wound up on January 21, '72, no less than £840 having been raised by the hard work of W. M. Clarke, G3VUC (who inspired the scheme) and his committee. Out of this sum, sixteen Cheshire Homes have been equipped. The balance remaining of £162 has been made over to the Torbay Amateur Radio Society to fit out a local Cheshire Home with a complete amateur-band station, for which Torbay A.R.S. will also provide an operator and train a resident for an AT-station licence. We congratulate G3VUC on a job well done.

WHEN ORDERING A SUBSCRIPTION

It would help the office work a great deal if you would make it clear, when ordering a subscription, whether it is for a new one, as distinct from a renewal—in the latter case (if not using one of our standard renewal forms) it also helps a lot if you can say, even approximately, from what month the renewal is due.

And another thing while on the subject: When sending in a change-of-address for the "New QTH" page *please* make it clear whether the change also applies to a *direct* subscription, since this involves a new plate through the addressing machine. If on the other hand you get the *Magazine* through a newsagent, and tell us so, we do not need to use valuable office time searching the Subscriber Index (which is maintained on a month-of-renewal basis).

The cost of a D/S is £3.00 for a year of 12 issues, first-class posting, or £2.75 second-class. In either case, despatch is always on the day before publication, normally the last Friday of the month. Orders to: Circulation Dept., Short Wave Magazine, Ltd., 55 Victoria Street, London, SW1H-0HF.

• • • **SWL** • • •

SHORT WAVE LISTENER
FEATURE

By Justin Cooper

**CALIBRATING A RECEIVER—SOME
TECHNICAL POINTS—LADDERS AND CLAIMS
—READERS' NEWS AND VIEWS—QUERIES
DISCUSSED AND ANSWERED**

BEFORE we dive into the mail this time, it may be of interest to consider how, with a signal-generator of doubtful accuracy and a 100 kHz crystal "pipper", one can calibrate a general-coverage receiver accurately, or trim it into line with the dial scaling.

Obviously, the 100 kHz standard needs first to be checked against an external, over-the-air standard-frequency transmission—such as the 200 kHz BBC signal, MSF Rugby, WWV, or such. Here lies the first pitfall. It is not the slightest use your tuning the 200 kHz LW station, and then trying to zero-beat your pipper, if only because you have no AF response in the receiver below about 100 Hz. No, what you do is to switch on the BFO and tune the Daventry signal for a good steady S-meter response and beat-note. Then switch your calibrator on, and tune it until it beats so slowly with the incoming BBC signal that the S-meter can be seen to be slowly rising and falling at a constant slow rate, and you tune it to make the rise-and-fall as slow as possible and independent of the main receiver tuning.

Now you come to the receiver you want to calibrate. With the pipper on, you will have a series of pips all the way up the band, but you don't know which one is which. You have to identify one for *sure* before you go any further. Right, so now change ranges to, say, the medium-wave band, where you *can* identify a pip as being say, 500 kHz and not 400 or 600, by reference to stations audible on the band. Set your signal generator to the frequency you have thus found. You now have a generator sitting on top of (beating with) the pipper, and both are on 500 kHz. Now, turn the receiver up to the Top Band range, where at 2 MHz you will have both pipper and generator harmonics on top of each other, and hence you can, by counting, find 1·9 and 1·8 MHz; 3·5 and 4 MHz appear the same way, with five points between. Indeed, you have now coverage from 100 kHz to as high as the *signal generator* harmonics will go; Eighty would be about the limit. OK, so what about the HF bands? Go about it the same way. On Forty, you have the 100 kHz pips, and you can set the S.G. on 3·5 MHz—which you already have calibrated in the first step—to find its second harmonic on 7 MHz and fourth on 14 MHz. For Fifteen, the safest way is to set the signal generator to the previously-calibrated 7 MHz point and take the third harmonic. And so it goes on. Notice, you are all the time working from the known accurate crystal pipper points. The generator is only used as a *transfer* standard, set on top of a marker pip to identify it for a moment, so it reckons not if the generator

drifts a little, or even if it is completely minus its calibration scale.

So much for frequency calibration—what about the pitfalls? The usual one is over-enthusiasm. *Never* twiddle a trimmer or core in an oscillator circuit unless you can bring it back to where you started, by eye. A tiny fraction of a turn at a time is the form. Get the oscillator right before you start tweaking the RF stage or aerial coils and trimmers. Once the oscillator is making the signals come up in the right places on the dial, you can then terminate the aerial socket in a resistor of about 75 ohms, and tune right across each band with BFO on, RF gain at max, and AF up to a comfortable level. All over the band the "sharsh" should have constant volume. If it does, you can try a more severe check, by varying the RF stage aerial trimmer (whether it is a front-panel knob or within) seeing if the thing will peak the sharsh. Set it to the point of maximum noise. If the receiver is OK, and the noise can be peaked in this way on all bands, particularly the higher ones, you won't miss much in the way of signals for want of sensitivity—this sharsh business is a very severe test of a receiver.

Finally, of course, reconnect the aerial through an ATU, and check that on all bands the ATU does produce a larger peak of signal, indicating that the correctly-matched aerial is putting in more signal over the noise-level of the receiver itself.

Then go chase the DX with an easy mind about your receiver—if you miss one now, you can blame it on the aerial (or the operator!)

HPX Ladder

Everyone on the new HPX Ladder, starting January 1 1971, should note that this month is the last time it will appear. The next issue of SWL will carry the same sort of ladder but starting with effect from January 1, 1972. This was all explained in the January issue, of course, but we mention it as a reminder. For those who intend to go on to the A-T-P-W (All-Time Post-War) Ladder, they should let us know next time round, so that the card can be kept in for you. In addition, it should be noted that one or two entries have already come in and been taken into the 1971 Ladder for this time.

Technical Points

J. H. Sparkes (Trowbridge), heard G2PU in QSO with ZL3UY, and the G signal had a marked "echo" effect; looking at the Great Circle map, one would think this is a case of receiving the same signal both direct—off the back of the beam in this case—and after it has travelled right round the world. This puts the echo to about one-seventh of a second after the direct signal.

R. Jones (Reigate) has a B.40 which appears to have a wobbly BFO on one band only. One would reckon that this is more likely to be a function of the mixer oscillator.

Neat SWL station of Tony Judge, 14 Hayley Bell Gardens, Bishops Stortford, Herts., who runs a BC-348 and SX-24 as receivers for all-amateur-band coverage. He is also interested in two metres. The aerial has been "50ft. of wire at 15ft." but was due to be improved when this was sent in.

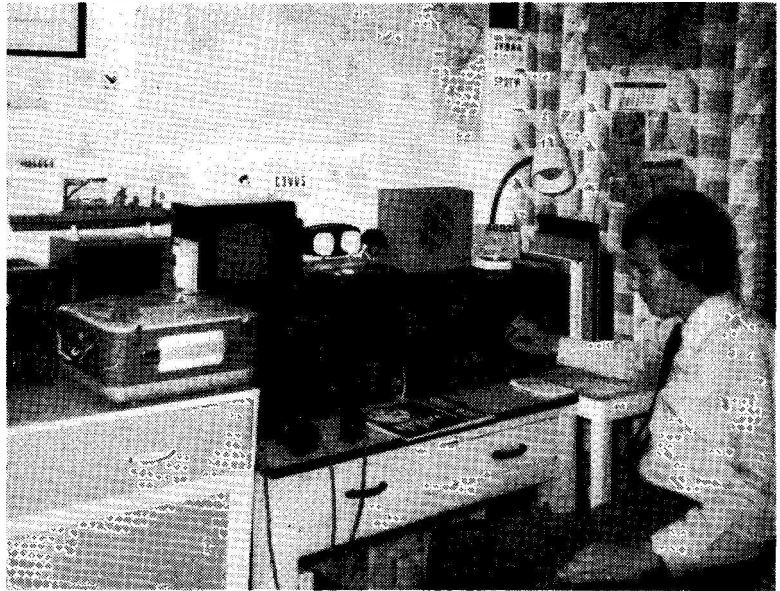

A good dose of switch-cleaner on the wafer of the band-switch used for switching the oscillator would probably clear things up no end.

Vacuum-cleaner noises are troubling *D. Shepherd* (Kingswinford) whenever he tries to listen. Taking the aerial off the receiver does not get rid of the QRM, so it seems it must be getting in through the mains. In this case the cure is to fit a mains filter right close to the back of the receiver, or, better still, attached to the back of the set. If you make such, don't forget that for 240-volt mains, allowing for the normal sort of expected short surges, you should use 1000-volt working capacitors in the filter.

For long now, your old J.C. has been preaching the advantage of using an attenuator with a receiver, on the LF bands particularly. *D. Rodgers* (Harwood) built the one appearing in recent issues of the *ARRL Handbook*, and has proved for himself its virtues. Dennis has a very well-equipped shack, at that, with Hammarlund SP-600JX and Sommerkamp FR-500DX receivers, an Eddystone 770R/1 for the higher frequencies, a BC-221, Heathkit 'scope, converters for 144 and 432 MHz, plus such antennae as a 14-AVQ, Joystick, end-fed wire, and Yagis for the VHF/UHF bands. In addition there is a transistorised two-metre set-up in the car.

Various points crop up in the letter from *O. L.*

Cross (Bexleyheath) who heard a VE8 working a VE7 on Twenty—but when the VE7 turned his beam round to work a VE2, his signal dropped in strength. Hardly what one would expect, admittedly, but it could be due to lots of things. Perhaps, in aiming at the VE2, Bexleyheath fell into the null off the sides of the beam; or it could have been a matter of long and short path propagation; or even that the signal was being turned into the ionosphere so that it appeared in U.K. to be coming in from an odd direction which reader *Cross's* aerial doesn't like. To turn to the prefix queries, VKØPF is OK—on Casey Base in Antarctica, while DF1WA could be genuine as a special-event station. As for the Soviet stations signing with R in the call instead of U, they are VHF-only licensees, the Soviet authorities regarding 28 MHz as a VHF band for this purpose.

Now to *J. Dunnett* (Leighton Buzzard), who offers some thoughts on the subject of ATU's. Jim has found he can cover from Top Band through to Ten in his scheme with only two sets of coils, his secret being to use a large variable capacity to peak up the link coil as well as tuning the main coil; and to adjust the amount of inductance in the system by pushing a bit of ferrite rod up the coils, which are made to be push-fits around the rod. A sound idea this, for receiving applications.

J. Jarvis (Rickmansworth) is a little bit worried by his aerial system, which needs an extra support. He wants us to tell him whether a forty-foot stick could or would need guys, how far away from the mast, and whether they should be based on concrete foundations. Sorry, Jonathan, but such questions as this can only be answered by the process of calculating, taking into account all the local site factors. However, the writer would feel far more secure if his masts were using guys of adequate strength with the bottom-ends tied to concrete well bedded-down. There are likely to be times when, for example, a halyard jams up top, and if the pole is well guyed, you can shin up it to rectify matters instead of

THE HPX LADDERS

The All-Time Post-War Listing goes on and the new Annual, taking in claims effective from January 1 this year, will start with the next appearance of "SWL", in the May issue. New claims should be made as soon as possible, and in any event not later than March 27, to: "SWL", Short Wave Magazine, Buckingham.

Part of the SWL layout belonging to Malcolm Newsome, High Inhams, Sutton-on-the-Forest, Yorkshire. Receivers include, from left to right, Trio JR-310, with mechanical filters, calibrator and Top Band conversion; Hallicrafters SX-111; tape recording gear and, at right, a Marconi "Atalanta" marine-type communications Rx tuning 25 kHz to 28 MHz. Not in view are a second "Atalanta" and a Drake Rx, together with linking panels and control circuitry for immediate recording facilities with any receiver in use—and very nice, too!



by a Codar CR-70A and three aeriols. There are hopes that before long the antennae will include a Mosley RD-5 and an ATU. As Geoff is on shift-work he is able to get on at times when we lesser mortals have to be at work—again lucky chap!

From the R.M. Barracks in *Plymouth*, we hear from *Cpl. S. Bell*, who was introduced to Amateur Radio by his friend VP8LR, and has since bought a Trio 9R-59DS. Now he would like to know whether there are any formal procedures about becoming an SWL. Not really, although if you are keen, it is a good idea to join the local Club if there is one within reach—see the Club Secretaries' Address Panel in "Month with the Clubs" in any issue of *SHORT WAVE MAGAZINE*.

On to *N. Gerdes (Basingstoke)* who has joined his local Club already—good! Nigel has now a Gelo G.209 in his shack, and remarks that it is interesting to notice how much one improves as one learns to drive the machinery to its best advantage, and stops concentrating on the strong signals—very true, and one of the things that make the difference between a good and an indifferent operator.

Now to *M. H. Smye (Parkgate, Wirral)* who is hardly a new boy insofar as he started as an SWL as long ago as 1936 and has just come back to it all, 36 years later! Michael turned up 14 of the DX QSL's he obtained in those far-off days, and was surprised to find no less than eight of them are still on the air despite the time lag and Hitler's War intervening. Interesting to notice also that son Richard, who is thirteen and at Shrewsbury School, is also a keen user of their K.W. receiver—and it all makes your J.C. wonder whether Dad started Richard off in SWL, or Richard brought Dad back into the game—either way, welcome to another father-and-son team in "SWL."

It really is surprising how odd the ways are in which one becomes interested in Amateur Radio. For *M. F. Winiberg (Penzance)* it was a visit to G3YZY—but there was Dad's old Hallicrafters SX-24 at home to be dug

out and put back in service for the younger generation, which sealed one SWL's fate! At first there was the receiver but no dials but later the dials as well were unearthed and refitted to make things a little easier.

Other News and Views

Sad to say, *R. Carter (Blackburn)* is in danger of losing his hobby—he is a pensioner and has a little sideline to augment his small income, enough to let him play radio; but it seems likely the sideline, and consequently his hobby, is shortly going to cease. Still, one lives in hopes; and to keep up hopes there is an entry for HPX which takes SWL Carter to 855.

Little time on the bands, reports *P. Harris (Surbiton)* because he is waiting for his R.A.E. result on the one hand, and practising Morse on the other. Big changes are also planned in the aerial department, to give coverage on Top Band and Eighty.

M. Kitchener (Hitchin) writes a nice chatty letter. He mentions hearing VKØPF, and deduced, correctly, that this station is in Antarctica; another snippet is that ZD9BM is the only one on Tristan da Cunha, the other two ZD9's being on Gough Island.

K. Plumridge (Southampton) says he is still an SWL even though he is now married! A pity he does not live down Dartford way, where all the YL's are licensed and active members of the local Club—they'd tear him limb from limb, or persuade his XYL to take up radio, for sure.

Now to *G. W. Raven (Lewisham)* who is at London University, although still, luckily, living at home, which means he can at least get on the bands occasionally. The event of the period was the arrival of a new box-o'-tricks in the form of a Trio JR-310, with which Geoff is exceedingly pleased. However, we may miss him for a while, as there are mid-session exams. to be worked for, and new courses to be started ere long.

D. J. Lockwood (Sharlston Common) is temporarily minus a receiver, as, anticipating a pass in R.A.E., he

is selling all his tackle to raise enough boodle for a new transceiver, or a good receiver in the event of an R.A.E. pass not coming through.

An odd form of QRM was reported by *P. Scragg* (*Stockport*) who recently gave up radio listening for ten whole days—to go to Hastings Chess Congress.

Our oldest inhabitant—the only one, we think, to have been with us since “SWL” was first started in *SHORT WAVE MAGAZINE*, way back in 1958—is *A. W. Nielson* (*Glasgow*). Arthur's KW-77 receiver finally decided to *force* him to mend it, by simply giving up altogether—the poor long-suffering beastie has now gone away for surgery, and the old CR-100 dragged out of the corner in the meantime. As for the aerial, A.W.N. still only has the lead-in part of his Windom connected—the rest parted company long since! However, since the Nielson establishment shack is at fifty feet a.g.l., and with a pretty clear view to the West, it is not really surprising that he does so well.

For *Mrs. R. Smith* (*Nuneaton*) listening time was severely eaten into by the preparations for Christmas, and by family illnesses—but Ruth still manages to put in a nice little collection for the prefix list.

H. M. Graham (*Harefield*) seems to have been at his particular grindstone whenever the bands were open—but still, Maurice has been at it for long enough to know that a dead band can sometimes be due to nothing more than no activity. Thus, on *Ten* there were W's and UA9's, not to mention G4MT—at two miles! *Fifteen* came up with a new one all-time in FL8MM, and EL9C putting in a steady signal. For the rest the loggings were W's, VE's, PY and PZ. *Twenty* was in poor shape on most evenings, but did give VE4—a rarity for Maurice—and KH6GDR, not to mention ET3DS, FG7TD, PY8LI, UF6CR, VP9AT, 5Z4DW and 9Y4T. On *Forty* the only pickings were all European, but on *Eighty* there was a brand new one in TA2QF, plus a couple of VE's. To his surprise and pleasure his reports have been acknowledged by some stations with nice words—and that *must* mean a good report!

T. Judge (*Bishops Stortford*) has not been able to get to his local Club meetings of late—a pity, as he could have been drafted for hon. secretary—but at least he can say that it has been all a matter of exam. preparation and hard work; and anyway, Tony can and does keep in touch with the locals through his receiver.

S. Wessely (*Sheffield*) has been laid up for a few days, and then there was all the school work to be caught up with, O-Level trials to be gone through and one thing and another, resulting in a total rise in HPX of but one—KS3CJ.

Yet another waiting for the R.A.E. pass slip is *S. Cole* (*Rogerstone*) who has come a long way since first he wrote in to this piece. Stephen has now got his 18AVT/WB into operation and has had a local amateur come over and pump some RF up it to prove it works OK. Stephen is one who likes operating rather than constructing—Stephen wields a soldering-iron most of the day and has had enough when he gets home.

A new twist to the theme of burying things metallic to aid the earthing system and its efficiency is reported by *A. West* (*Herne Hill*) who buried, among other things, an old electric toaster(!)—one way of getting rid of QRM! A.W. has joined the Crystal Palace Club, so no

NEW HPX LADDER

(Starting January 1, 1971)

| SWL | PREFIXES | SWL | PREFIXES |
|----------------------------|----------|----------------------------|----------|
| PHONE ONLY | | PHONE ONLY | |
| K. Plumridge | | K. A. Hastie (Jedburgh) | 303 |
| (Southampton) | 479 | T. J. Thornton (Wargrave) | 295 |
| M. J. Winiberg (Penzance) | 437 | M. Kitchener (Hitchin) | 295 |
| P. Goff (Towcester) | 432 | Z. Parmigniani (Stockport) | 275 |
| Rev. L. J. Turner (Dudley) | 428 | A. West (Herne Hill) | 271 |
| J. V. Parker | | G. Ridgway (Basildon) | 268 |
| (Newcastle-on-Tyne) | 424 | P. N. Newman (Thame) | 265 |
| H. Stephenson | | R. Impy (Brentwood) | 252 |
| (Newcastle-on-Tyne) | 397 | M. J. Wayland (Leicester) | 240 |
| N. Gerdes (Basingstoke) | 383 | W. & J. Bingham | |
| M. Marsden (Ilford) | 364 | (Carrickfergus) | 230 |
| H. R. Goodwin (Streetly) | 356 | J. Gravell (Burry Port) | 228 |
| Miss L. Hyder | | S. Clark (Charterhouse) | 211 |
| (Southampton) | 353 | R. Jones (Caerphilly) | 211 |
| Mrs. R. Smith (Nuneaton) | 351 | R. C. Jones (Reigate) | 216 |
| J. Iredale (Llandudno) | 340 | K. M. Rogers (Ullesthorpe) | 207 |
| R. Philpot (Shenfield) | 335 | C. Witts (Gloucester) | 201 |
| O. L. Cross (Bexleyheath) | 331 | | |

Listings include only recent claims. Starting score 200. Rules as for HPX. This is the final appearance of the 1971 Table. Next appearance, in May issue, will show starting date as January 1, 1972. Deadline March 27.

doubt G3FZL will be guiding him along the road to a call of his own.

Joining the ATC has cost some listening time for *Z. Parmigniani* (*Whaley Bridge*), but turned out to be of interest insofar as among the ATC tackle there are three receivers—one unidentified, an R.1155 and an HRO, plus a couple of 54 Sets, a 38 Set and a Codar A.T.5—all they need is an operator! Zorro will now be *much* keener on Morse, no doubt!

W. B. Taunton (*Meopham*) found the going a bit hard towards the end of the year, conditions seeming to have gone decidedly to the dogs since October; however, he says his XYL gave him a Hamgear preselector for Christmas, which argues he is better off than most of us in his hobby!

Let a licensed chap have the last word or two this time—G4AIQ (Barrow-in-Furness) who, amongst other things, asks for more tables and ladders for VHF SWL's, to help combat the sometimes appalling operating heard on Two from new G8/3 stations. As he says, they are scared of Morse—so was he!—and do not venture to listen on any band, let alone 144 MHz, until the R.A.E. pass is in and a G8 call possessed. G4AIQ goes on to relate the rush on to Two to the depopulation of Seventycems, and to the loss of a big chunk of that band to other interests. Finally, just in case a G8/3 operator feels inclined to hit back at G4AIQ, we ought to mention that G4AIQ conceals the identity of a well-known G8 of yore. And, it has to be said, the problem is just as bad on the HF bands—we just do not seem to get many of the beginners to do any SWL'ing before passing the tests. After all, a simple receiver with only one valve or a transistor or two would be enough to go far along the way and learn the techniques of the listener and the operator.

On Tape

Many radio enthusiasts are also tape-recorder addicts, and they will doubtless be interested in the British

Amateur Tape Recording Contest, 1972. There are classes for Speech and Drama, Documentary, Music, Reportage, Technical Experiment, Schools, and Sounds from Nature. Details from the Secretary, 33 Fairlawnes Maldon Road, Wallington, Surrey, who also will have the application forms for entry.

Other Letters

Here we can acknowledge and thank those who sent in a list for the Tables, which we have taken in, with brief covering notes or none at all—just as welcome as the long chatty letters, so keep 'em rolling!

These include R. A. Jones, *Caerphilly*; K. Webb, *Reading*; M. J. Quintin, *Wotton-u-Edge*; M. Marsden, *Ilford*; J. Halden, *Baldwins Gate*; R. Mortimore, *Cardiff*; T. Rootsey, *Ilford*; E. W. Robinson, *Bury St. Edmunds*; J. Woods, *Woodbridge*; R. Bence, *Cardiff*; A. Glass, *Plymouth*; R. Shilvock, *Lye*; P. L. Newman, *Thame*; and P. L. King, *Isle of Wight*.

Sign-Off

This is where we make our farewells to you all for another spell; but keep on with your letters, the deadline for next time being to arrive by **first post March 27**. The address, as always, is "SWL", SHORT WAVE MAGAZINE, BUCKINGHAM. 73!

POOR R.A.E. RESULTS—MAY 1971

Only 905 (54.22%) of the 1669 candidates who took the 1971 R.A.E. managed to score a "pass". This represents one of the poorest results on record and continues the decline in the success-rate over the past three or four years. The obvious question to follow is—why?

We at SHORT WAVE MAGAZINE have maintained for many years that the pass-rate should be more or less stable around the 65% mark, this figure arrived at by considering the academic level of the Exam. and the likely ability of those showing sufficient interest to embark on an R.A.E. course. Something like this figure has, in fact, been consistently achieved in the past.

It could be said that some of the questions were above the required standard, as was thought to be the case in the 1970 paper, but two points must always be borne in mind: First, the pass figure is only 50% and, secondly, the first two compulsory questions (Part I) must be considered as being "give-away", as they only require the memorising of the relevant rules and regulations—and they alone account for 30% of the total marks. Therefore, only another 20% has to be gained from the remaining six questions (out of a choice of eight) to be attempted in Part II to secure a "pass" slip.

The general feeling seems to be, at any rate as far as the 1971 paper is concerned, that *four* of the questions in Part II were very fair and should have presented no difficulty to the well prepared candidate, while the remainder might, perhaps, have been somewhat beyond the scope of the syllabus, or rather too time-consuming to answer fully. The inference must be, then, that the root of the trouble lies in inadequate teaching in some classes and insufficient personal effort by the candidates themselves.

CELESTIAL X-RAYS

The area in which astronomers may find a visible object to connect with the celestial X-ray source GX3+1 should be narrowed even further following a successful rocket-borne X-ray astronomy experiment at Woomera, Australia on October 24. The identification of GX3+1 with a visible object using optical astronomy requires a very precisely defined area in which to search, and an experiment on September 27 by Dr. K. A. Pounds' team at Leicester University took a "bearing" which shows that this X-ray source is in a very narrow sky area. The present experiment, by the Mullard Space Science Laboratory of University College, London, has provided a "cross-bearing" reducing the area to be searched by a factor of 60. If astronomical observation does reveal a star in this area it is likely to be the source of X-ray emission GX3+1. Taken together, the experiments have reduced the error box by a factor of 1000—quite a factor.

The two experiments, funded by the Science Research Council and involving very sophisticated techniques, took advantage of the only two occasions this year during which X-ray emission was eclipsed by the Moon, as seen from Woomera. The MSSL experiment was launched in a spin-stabilised *Skylark* rocket and the payload, a 1000 sq. cm. area X-ray counter giving a field of view 20° by 6° with the 20° axis parallel to the Milky Way, was spun at 3 revs./sec., thereby sweeping across GX3+1 three times a second. The counter could not be directed at the X-ray source continually throughout the flight until occultation, since this occurred at a time when neither Sun- nor Moon-stabilised *Skylarks* could be used. Nevertheless, it is expected to have had an accuracy in the direction of relative motion of the source with respect to the Moon of two secs. of arc. From the results, it is expected that much more will be learnt about the mysterious GX3+1. In the mapping of space, this is the sort of nomenclature used to identify objects, visible both telescopically and in the radio-noise sense.

NEW COMMERCIAL MOBILE ADD-ON AMPLIFIER

G.E.C. have produced a new linear solid-state add-on amplifier to increase the output of low-power AM radio-telephones to their high-power equivalent, from about 5 watts to 25 watts. Weighing only 2½ lbs. the amplifier has only to be connected directly to the aerial and power supply; flying leads connect with the transceiver and thence operation is completely automatic. The amplifier unit "senses" a transmitted signal from the vehicle radio and switches the amplifier into the aerial circuit. When the set reverts to "receive" the unit cuts out the amplifier and establishes straight-through connection between aerial and receiver side. The amplifier gain approaches 10 dB at 174 MHz with supply voltage 11v.-16v. and its frequency range is 71.5-88 MHz, 105-108 MHz and 156-174 MHz.

For this month's Readers' Small Advertisements see pp.58 to 64.

VHF BANDS

A. H. DORMER, G3DAH

IT'S the old, old story as far as propagation at VHF/UHF is concerned—almost uniformly dull. Those of us who have been operating on these bands for some time have come to accept that this period of the year sees very little in the way of DX, but it must be heartbreaking for the newcomer, all full of enthusiasm, to find that he can do so little. One cannot help but think of the chap who comes on, say, 70 cm, with new gear, and who hears so very little night after night, until the dreadful doubt comes into his mind that all is not well with the equipment, and vistas of long, weary evenings spent trying to trace some obscure fault, which in fact does not exist, speed before his dulling eyes. To them, "do not be fright," *sursam corda* and all that. It will all come back—it always does.

Two minor lifts noted in the South on two metres are worthy of mention—that on January 23 when the path was open between Yorkshire and the South, and on January 28 when Midlands to South working was on. In spite of the heavy snowfall over much of the country at the end of the month, the pressure was quite high at times, 1022 mB in Herne Bay on January 29, and between the showers, 100-mile contacts were fairly easy to come by. There was a marked drop in activity levels during the month, and one suspects that a goodly number of operators had a quick listen round

the bands and did not bother to make a call. It *does* pay to have a go, even into an apparently empty band, because there is always someone listening. Here is just one example: G3DAH called CQ on 2m. into a quiet band on February 4, and was answered immediately by G6NB near Aylesbury and then by G3OHH in Mow Cop. After a quick QSY to 70.26 MHz, the QSO with 'OHH was continued on that band. So two out of the three bands were open. And look at G8CIW and G3NHE in the Annual VHF Tables, who have worked 23+3 and 31+2 respectively since January 1! They certainly didn't do that by just listening. So the moral is—have a go!

Three-Band Annual VHF Tables

A good start to the Tables in spite of the generally poor propagation at VHF/UHF since the beginning of the new year. G5DF (Reading) at the head of the list, is to be heard on one of the bands most nights, and GD2HDZ seems to have got off to a flying start from his new QTH, although one assumes that he is not quite ready to go on 4m. G3NHE in Sheffield and G8CIW (South London) obviously have been burning the midnight oil on Two! If, as we hope, you are entering the Tables this year, now is the time to start, before you have to wade through all those pages of log to get the totals out.

A plea here: When claiming for these Tables, *please* ensure that your callsign is given. It's all very pally to get a letter saying "please add 3 counties to my previous total, Bill", but the research needed to find out just who "Bill" is takes much time and can lead to errors.

Contests

Conditions for the 2m. SSB contest on January 9 were poorish although, from time to time, a 200 km. signal could be heard through the noise. G3SHK (Ruislip) made a welcome reappearance on the band and was putting a 5 & 7 signal into the Midlands, and scores of 035 and 043 were being passed near the end of the contest by a station in Rushden, Northants. and G3DY (Peterborough) respectively. It is

under these conditions that SSB demonstrates most clearly its superiority over other modes of phone transmission. Some of the QSO's heard would just not have been possible if NBFM or AM had been used.

The 70 cm. Cumulatives continue to be bedevilled by poor conditions. On January 14, the best score heard was that of G8BBB who passed 023 at the end. GD2HDZ was apparently just audible in the Midlands although, as far as can be ascertained, he made no contacts south of Birmingham. January 22 showed some improvement in propagation with typical finishing scores such as G3EHM at 023, G8BBB at 022, GW8ERP/P (12 km. W. Wrexham) at 025, G3OHH on 020 and G8ACB at 027. On January 30 conditions in the South were very poor indeed, so much so, that it was impossible to get an idea of activity generally, but report has it that things were very much better in the Midlands, with G8ACB on 032, G3UBX on 022, G3KMS on 022, and G3OHH (who was unable to start until just before 9 p.m.) also on 022—which probably goes to show that when conditions are flat, one can work all that one can hear in half the time. It also suggests that activity in the Midlands must be much higher than in the South. For some nice DX, GD2HDZ and G3KMS managed a good contact, although the signal reports were well below normal. Propagation looked more promising for the February 7 session, in that the Sutton Coldfield beacon appeared out of the noise for brief periods in the South, and it hasn't done *that* for some time! Sure enough, several good DX contacts were made such as, for example, that between G3EHM near Stoke with G8AHF in the I.o.W., but it was a question of being in the right place at the right time, since such lifts as occurred were confined to short periods only, and by the end of the contest conditions were back to uniformly dull.

Forthcoming events are the remaining 70 cm. Cumulative on March 2, and the 144 MHz Open over March 4-5.

VHFCC Awards

Another goodly number of claims for membership of the VHF Century Club have come in this month. One suspects that totting up the scores at the end of the year has something to do with it! Be that as it may, we are always glad to welcome new members among the regular readers, and to make the Award in recognition of their achievement, which is still not all that easy, in spite of the increased activity on 2m. Getting in the requisite number of QSL cards remains one of the difficulties!

Although the qualifications for membership have been published several times, enquiries are still being received, so here again are the essential features of the scheme.

First, you may claim the Award for 100 *confirmed* contacts on either four metres, two metres or 70 cm. (This does not preclude you from making a claim for more than one of these bands if you have the necessary confirmed contacts per band.) Secondly, you should send in a list of the 100 stations you have worked, and whose QSL cards you hold, giving the callsign and the date on which the contact was made. You will then be asked to forward six QSL cards, chosen at random from your list, for verification purposes. If these are found to be in order, they will be returned to you with the Award confirming that you are now a member of the VHF Century Club. Thirdly, please note that all contacts must have been made from *one QTH only*, i.e., you cannot include a mix of /P or /M stations, and this means that it is jolly hard luck on those who move QTH half way through the collection—they will have to start all over again. To elaborate slightly on the above, QSL cards *from* mobile or portable stations *are* admissible. Fourthly, please include with your claim a description of your station, gear used, antenna, QTH characteristics, when you started on the band, and an idea of the % QSL return—not that these are in any way qualifications, but they are of interest to readers. After all, it is an achievement, and would-be claimants often like to know how it was done. There is no charge. Send your claim to "VHF Bands," SHORT WAVE MAGAZINE, BUCKINGHAM.

First Award this month goes to G8EBJ, who gets Certificate No. 129 for operations on Two. Now this is a slightly unusual one in that Jim Davies already holds one Award for the band but, as a student, he operated from a fixed private address in London for a time, and worked his 100 stations from there, after having done so from his home address in St. Leonards-on-Sea. Incidentally, he must have had one of the best QTH's in the Metropolis, up near the top of a tower block of flats on the hill in South Woodford. (Your scribe recalls a mobile QSO with him which culminated in an SHF contact, (heliograph) since it consisted of an exchange using the car headlights and a table lamp!) The gear used for his claim was a Hudson AM112 transceiver running 15 watts to a QQV03-20A modulated by a pair of OC28's. The Rx consisted of a BC-342 with a dual-gate Mosfet converter. The antenna, a 6-ele Yagi on top of the flats, was rotated by a nylon cord from a position some 45ft. below. With a site like that, Jim says that he spent rather too much time on the air and not enough on his studies, so he will be QRT for a time while

he catches up!

Award No. 130 goes to Maurice Lee, G8EJH (Sidcup), who runs an Emsac TX2 with a QQV03-10 PA running at 12 watts input, series-gate modulated, although from time to time a Vanguard with a QQV03-20A in the final and 20 watts DC input was used. The Rx is an FR-100B with a nuvistor converter and the antenna, originally a 6/6 slot, is now a 14-ele Parabeam.

Steve Haseldine, G8EBM, operates from West Bridgford, Notts. and gains Award No. 131 for two-metre contacts. He has been on the air since September 1970, running a Pye Base Station with a QQV06-40A in the PA. The receiver is a modified R.1475 with a Fet pre-amp and a dual gate Mosfet converter. The 8-ele Yagi is at 16ft. In the building stage is a 150-watt rig for NBFM.

G3UZ (Goring-by-Sea, Sussex) receives Certificate No. 132 for two metres. He runs an HW-30 at 5 watts to a 6-ele folded Yagi at only 25ft. a.s.l. The receiver is a Geloso G.209 (one doesn't hear of many of these nowadays) and a CN2 nuvistor converter.

To Dunstable, Beds., for the next Award, which goes to Norman

THREE BAND ANNUAL VHF TABLE

January to December, 1972

| Station | FOUR METRES | | TWO METRES | | 70 CENTIMETRES | | TOTAL pts. |
|---------|-------------|-----------|------------|-----------|----------------|-----------|------------|
| | Counties | Countries | Counties | Countries | Counties | Countries | |
| G5DF | 5 | 1 | 22 | 2 | 13 | 1 | 44 |
| G3DAH | 3 | 1 | 18 | 2 | 9 | 1 | 34 |
| G3NHE | — | — | 31 | 2 | — | — | 33 |
| GD2HDZ | — | — | 19 | 3 | 8 | 2 | 32 |
| G8BXX | — | — | 19 | 1 | 9 | 1 | 30 |
| G8CIW | — | — | 23 | 3 | — | — | 26 |
| G4ALN | — | — | 12 | 1 | 9 | 1 | 23 |
| G8AGL | — | — | 20 | 1 | — | — | 21 |
| G8EMS | — | — | 18 | 1 | — | — | 19 |
| G3OHH | 5 | 1 | 1 | 1 | 7 | 2 | 17 |
| G8BKR | — | — | 6 | 2 | 4 | 2 | 14 |
| G4AVX | — | — | 5 | 1 | — | — | 6 |

These Tables go through to December 31, 1972. The Three-Band Annual Tables show claims to date for the year commencing January 1, 1972. Claims should be sent to:—"VHF Bands", SHORT WAVE MAGAZINE, BUCKINGHAM, as they accrue.

Down, G3SRX, who must be very pleased with his new QTH at 600ft. a.s.l. compared with the previous place in Nottingham, where the height a.s.l. was a mere 12ft. and surrounded by hills! He runs a Pye Base Station, converted to radiate some 30 watts of NBFM, an AF139 pre-amp and BF180 converter to an HRO and a 6/6 slot at 35ft. This set-up gains him Certificate No. 133. Although his claim is for 2m. only, he also has 70 cm. and can receive A/TV.

An interesting claim which includes some very nice DX comes from John Hobin, G3XIX (Felixstowe, Suffolk), Award No. 134. Some 70% of his contacts, all of which were made on two-metre SSB, were with stations *outside* this country, and those of us who have heard John's beefy signal, and know the area from which he radiates it will not, perhaps, be surprised but it is, to say the least, unusual, and the first claim of this proportion which has been received. He uses a KW-2000A as the prime mover with the usual transverter, and power inputs starting at 5 watts and rising to 450 watts (200+ watts PEP out). Antennae have been a 4/4, recently replaced by an 8/8 at 120ft. a.s.l.

Paul Brown, G8EGS/G4AJE (Kettering, Northants.) claims for Certificate No. 135. He was first licensed in Spetember 1970, and at that time ran a converted Pye Ranger which was later modified further to give 45 watts in a QQV06-40A, and this is in operation to date. Having obtained his G4 call in August 1971, he has now acquired equipment for the HF bands and is planning 2m. SSB with a transverter set-up. He uses a dual gate Mosfet converter for reception and the beam is a 10-ele Yagi at 250ft. a.s.l.

Finally, to Maurice Cartwright, G8EKY of West Bromwich, Staffs., now the holder of Certificate No. 136. He started operating in March 1969 with a 0.5 watt NBFM rig and a 19in. whip, but this obviously had its limitations and, subsequently, the Tx output power was doubled and the whip replaced by a 4-ele Yagi, this equipment producing regular contacts at 50 miles. Further development work led to the present set-up, which includes a QQV03-

20A with 40 watts input, amplitude modulated, and a 8 ele-Yagi at 26ft. For reception, Maurice has a JXK Mosfet converter and an IF strip comprising an Electroniques front-end tuning 28-30 MHz, and a 2nd IF of 1.62 MHz feeding the Eddystone 680X. His latest acquisition is a Sommerkamp FR-500. He is also active on 70 cm. with about 4 watts of NBFM and an 18-ele Parabeam at 29ft. at the 500ft. a.s.l. site, and is open for contacts most evenings on 432.05 MHz. Plans for the future, when realised, will up this power to 30 watts, so he should have a pretty fair signal over most of the Midlands.

That's if for the present, and it remains only to congratulate those concerned. Just one last thought. Having proved their ability to communicate, what about members of the Century Club entering their scores for the Annual VHF Tables?

North of the Border

In an area where the density of VHF operators is low, the terrain difficult and current propagation conditions poor, the news from Scotland must inevitably be sparse but it is a pleasure to record that, with their customary doggedness, our Northern neighbours are busy introducing new recruits to the VHF bands, and preparing for the summer months. Graham Knight, GM8FFX (Aberdeen) is not even waiting for the summer. He is planning to operate from that wonderful site in Kincardine, Cairn o' Mount (should this be Cairn o' Mounth? The maps show both spellings, but Scottish history of the Middle Ages would suggest that the latter is more likely to be correct), for the contest on March 4-5, and will have 2m. and also 70 cm. with 75 watts to a 46-ele beam on 433.350 MHz, which makes this trip even more attractive from the UHF/DX point of view. Skeds can be arranged *via* PO Box 49, Aberdeen. and with him will be Alec Allan, GM3ZBE no less, so it is to be hoped that there will be some CW activity also, which will give we Southerners a better chance.

The indefatigable George Burt, GM3OXX, will be doing a "Monroe" during the summer months, and for those who, like G3DAH, wonder what this is (and

if it is connected in any way with the Doctrine or Marilyn), you may relax—it is a classification of mountain heights over 3000ft.! In short, George, and a party of intrepid climbers, will be scaling no less than eleven of these Scottish peaks, and will be operational from eight of them. They will give a special award for anyone working them from five or more locations, so watch this space for further details nearer the time. As noted last month, George is QRV on 3 cm., as are GM3DXJ, GM8BKE and GM8CGS. In addition to the foregoing, he will be on from the Cheviots over the weekend April 15-17, so look out for GM3OXX on 145.72 MHz.

While on the subject of expeditions, it might be as well to recall that intending visitors to GM during the summer would do well to contact the local amateurs early in the planning stages. This precaution will not only avoid on-site clashes with other occupants, but could also have advantages when it comes to site selection, where the advice of those with local knowledge is likely to be most valuable. It is also good manners. A chat on this subject with GM6XI of Edinburgh produced the information that visitors are very welcome, and that he would be willing to co-ordinate matters in the Edinburgh area. GM3BRM would help in the North and GM3WIG in the Border Country. All *QTHR*. One other point to be considered is the frequency it is proposed to use. If the only aim of the trip is to work into G, then it is not essential to be equipped for operation in the top 200 kHz, but if GM working is envisaged, then it is as well to recall that many GM operators cannot tune *outside* 145.8 MHz to 146.0 MHz, and the QRG should be planned accordingly. Just a reminder also, that 145.85 MHz to 145.95 MHz should be kept clear for GM phone operators trying for the DX to and from the South.

Two newcomers to the two-metre scene are GM8YKA (Glenrothes) and GM3BQA (North Berwick, East Lothian). The latter is Jimmy McCaig, one of Scotland's well-known HF-band operators. Old Timers may recall the GM3BQA Quad which at one time was in widespread use over much of the country.

What may not be so well known is that he has represented Scotland in car rallies and competitions on many occasions. He will be operating NBFM from a first-class site, and also has plans for mobile operations.

Further North, GM3SBB (Kirriemuir) is beginning to think that there is something in this VHF lark after all, but is hampered by local regulations banning outside hardware. You can make a long wire look like a clothes line, even though the insulators take a bit of explaining, but what to do about the two-metre beam? One suggestion from a friend is that he should convert the chimney cowl into a cylindrical slot! However, it should not be too long before he finds a solution to the problem. (Anyway, a two-metre beam can always be "a special TV aerial"—and nobody would dare deny the god of the box!—*Editor.*)

GM8BZX, Frank Hall, Forfar, can now radiate 30 watts of AM or 120 watts of NBFM from the same 12-ele beam at the flick of a switch. Incidentally, the rotation system for the mast, which also carries a corner reflector for 70 cm., is quite ingenious. The mast, which is on top of the home-constructed 40ft. tower, is turned by a reversing windscreen wiper motor suitably geared down through an HRO tuner gearbox, and this is chain-and-sprocket coupled to the mast. He should be operating mobile from the Scarborough area during the week commencing April 10, and says that he is likely to be on most nights after closing time! Frank finds activity low, and suggests that even GM2DRD must be hibernating for the winter. GM3GUI is maintaining the nightly 10 p.m. sked with GM3JFG up in Invergordon, but apart from that, there seems to have been little regular activity.

Hail and Farewell

Two new calls on the bands are G4ASR (*ex*-G8ASR, London) and G4AVX, *ex*-G8CXC, Portsmouth. G4ASR runs 150 watts to a 12/12, and would welcome 100+ mile skeds to the North. There is likely to be a new call sign heard from Jersey shortly—GC3GPL, St. Helier, expects to be QRV on two metres when he gets settled into the new QTH. Welcome back to England to Ian Dredge, G8ATV, Malmes-

bury, Wilts. His trip overseas did not last as long as he expected, and one looks forward to hearing his potent signal on the band again.

We very much regret to have to report that Lt. Col. Norman Bower, O.B.E., G5HZ, of Peppard, Oxfordshire, passed away suddenly on January 24. His call was often to be heard on two metres, particularly during contests.

G3UGF/MM has now quit the

sea and gone into industry, but once he has got himself settled he hopes to be on the VHF bands again, probably from Wetherby, Yorkshire. During his six months afloat, he made over 500 contacts on Two and found it a unique experience—*see* article pp.728-730, February SHORT WAVE MAGAZINE. He sends his thanks to all who helped him to achieve this result.

Although his call will not dis-

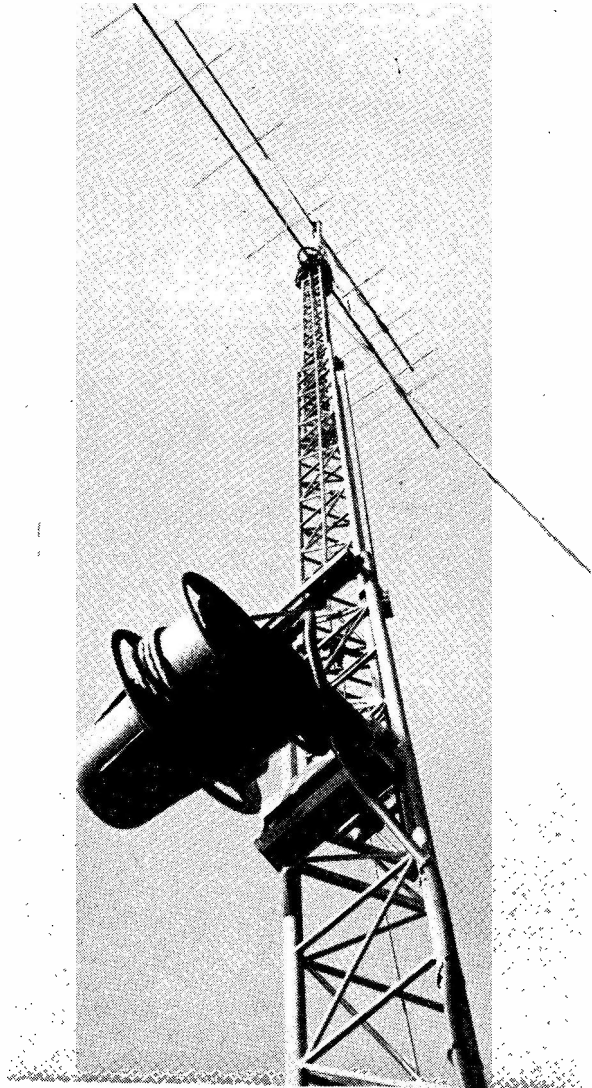

Two-metre beam at G3RAC, the Racial Amateur Radio Club station, consists of a pair of stacked Yagis, in the 10-over-10 configuration, mounted on a Strumtech transportable mast. The Club membership is made up of licensed amateurs employed by Racal-Electronics, Ltd., of Bracknell, Berks., and they enjoy the full support of the firm, well known in the field of commercial radio communication.

appear entirely from the UHF/VHF scene, at least not immediately, we are likely to hear much less from Ian Sneap, G3ZYC (Pentrich, Derbys.) a front runner in the Tables, who has taken the decision to concentrate all his spare time on getting an engineering qualification. He has always been a devotee of 23 cm. and the measure of his success on that band is shown by the fact that he worked 14 counties and three countries during 1971.

Ionospheric Heating

The *Journal of Geophysical Research* has an account of some interesting experiments which are being carried out from Arecibo, the vast "natural" radio dish in Puerto Rico. Scientists there have been able to produce a bubble of hot plasma in the ionosphere, some 100 km. long and 50 km. wide, by beaming radiation from a 100 kW transmitter, operating in the range 5-10 MHz, at the F-layer. This has produced "modifications" to the reflecting properties of the layer, which can be plotted by a new 430 MHz radar, and it has shown that the temperature rise can be as much as 300° above the normal 1000°C of the region. There are thus practical implications in this technique, and ionospheric modification may become a valuable tool in radio circuit planning. The rumour that the bubble observed on the 430 MHz radar had anything to do with the radiation from G3--- during his E-M-E experiments is, naturally enough, hotly denied!

News Items

An interesting addendum to the news about the 2m. opening to the South of France and Spain on December 12 last comes from G8EMS, Leeds. After giving an impressive list of French stations logged during the afternoon, he reports reception of an EA on *phone*. The signal was mostly around the RS32 mark, and he could not identify the callsign with certainty. All reports to date have indicated that EA1AB and EA1CP, who were known to be active and working U.K. stations, had refused requests to use A3, so who was the other? No one else has yet reported hearing a third

Spaniard, but further information would be welcome.

Talking of France, here is one for the certificate hunters. The amateurs in Calais have created the "Diplôme des Six Bourgeois de Calais" which will go to any operator working six of the following stations:— F1XY, F1APQ, F1BRN, F2YA, F6ASP, F6AZS, F6AZW, F6AUQ, F6AWT, F6BQH (ex-F1AOY), F6BQO, F6BQP (ex-F1BCI), F8EH and F9RS. The contacts must have been made after January 1, 1971, and claims, without QSL cards, should be sent with four IRC's, to: F6AZW, 8 rue de la Tannerie, 62 Calais.

G8EXM (Bickley, Kent) is planning a trip to the Lake District in August and hopes to be operating from the summit of Scar Fell Pike which, at 3,210ft., is the highest mountain in England. He will have two-metre gear with him, and to assist in planning would like to hear from a two-metre operator in the Keswick—Cockermouth area of Cumberland. QTH: 1 Melbury Grange, Mavelstone Road, Bickley, Kent.

It appears that antennae are getting higher and higher these days. G8BCG in Manchester, G3SXC (Blackburn) and G3MYI of Leicester have all sprouted towers. G8BCG has two Multibeams on a 15ft. pole which gives him an effective height of 75ft., which should make some impression on the DX. His Tx runs 30 watts *output* on 70 cm. from a carefully blown QQV03-20A. The Rx has an ML500 pre-amp, and Peter says that stations such as G3UBX in Wolverhampton are now readable at S8 compared with *nil* reports in the pre-tower era! G3MYI runs 110 watts to a QQV06-40A with 2/TT21 as modulators for AM. A new PA with a pair of 4CX250R's is on the way, and 4m. gear is in the planning stage.

G3NHE (Sheffield) has only been on the band for a short while, but has knocked up an impressive total of counties, and his countries worked on Two include EA. It took 20 attempts to raise EA1AB and 13 calls to get EA1CP back and he wonders where all those CW stations in the South came from! He is another advocate of calling into a

seemingly flat band, and suspects that the bands are capable of supporting many more QSO's over the 150-mile mark than activity suggests. With which sentiment this Column agrees! He has at last got the QQV06-40A PA going, and is running 45 watts input in Class-AB1 for AM and 60 watts Class-C for CW. He is planning SSB on two metres but will first complete the 70 cm. gear.

Club and Group Activity

Advance notice comes from the University of Manchester Amateur Radio Society (G3VUM) that they are planning a trip to the Isles of Jura and Islay at end June—beginning July. They will have high-power CW and SSB on 2m. and there is a chance that they will also carry 4m. and 70 cm. gear with them. Further details later.

The British Amateur Teleprinter Group have a convention laid on for May 20 at the village hall, Meopham, Kent. They will have RTTY on the HF bands and two metres and talk-in stations are being set up for 2m. and 4m. mobiles. The programme includes lectures and demonstrations, (of the peaceful kind of course), and further details can be obtained from the contact man J. D. Heck, G3WGM, *QTHR*.

The next meeting of the South East UHF/VHF Group is scheduled for March 3, 7.30 p.m. in the Electronics Building, University of Kent, Canterbury. The speaker on this occasion will be Dr. Kenneth Smith, B.Sc., Ph.D., G3JIX, who has as his subject "Microwaves".

Deadline

That's it for the time being. The deadline for the next issue is **March 11** and the address: "VHF Bands", SHORT WAVE MAGAZINE, BUCKINGHAM. If the industrial dislocation due to power cuts has delayed this reaching you—as it well might have done—please note *April 8* as the deadline after, for the May issue. Best thing is to send in whatever you have as soon as you can. Cheers for now and *73 de G3DAH*.

TVI AND STUBS

LOOKING AT THE FACTS

E. JOHNSON (G2HR)

THE numerous methods of coping with TVI need no recapitulation here. Although the basic principles can be followed, the solution so often revolves round trial and error. For this reason the writer will consider the $\frac{1}{4}$ -wave stub only.

Loss-Free Lines

A perfect $\frac{1}{4}$ -wave coax line when shorted at one end would exhibit an infinite impedance at the open end. In practice this never happens, although the impedance is very high. Theoretically, an open-ended stub would act as a complete short when cut to any offending frequency at the "home" end, *viz.* transmitter output.

Practice

No practical line is absolutely loss-free. The open-ended point has a very high impedance of low-loss, and is consequently not zero at the other end. The familiar $\frac{1}{4}$ -wave transformer formula $Z_o = \sqrt{Z_{in} Z_{out}}$ where Z_o is equal to line characteristic impedance is more

useful if expressed as $Z_{in} = \frac{Z_o^2}{Z_{out}}$. Clearly only input

impedance of zero would be obtainable if open-end impedance were infinite. The former can be very low with good quality line at the resonant frequency.

Line "Q"

The use of UHF coax can have its drawbacks. Owing to the high "Q" attenuation will be high, but the rejection bandwidth will be narrow. Because of the large band-

width on vision, little may be gained. There is a reasonable case for a lower "Q" line with a velocity factor of around 0.66. Even here results can be disappointing. A compromise can be effected by bridging the open end with a non-inductive resistor of around 75 ohms. The formula already quoted will show that equivalent resistance at the "home-end" will be 7.5 ohms. So long as the latter is small compared with the 75 ohms output, there will be reasonable attenuation with greater bandwidth because of the lower "Q." It is largely a matter of trial and error. Do not fall into the beginner's trap—it has been known—of thinking you can install the stub in the TV receiver. You certainly will attenuate your harmonic, *and* the vision!

Snags

At all frequencies lower than the resonant frequency an open-ended stub behaves as a capacitance. The value can be determined by the formula $X_c = Z_o \cot l$ where "l" = line length in electrical degrees. At a frequency of 28 MHz the electrical length will be around 56° , assuming we are primarily concerned with 45 MHz vision frequency. The capacitive reactance will thus be $75 \cot l$, or $75 \times .67$ which equals 50 ohms, near enough. This is equivalent to 120 μF roughly. This may well exceed the required resonating capacitance in the *pi*-section output when the transmitter is properly loaded. On other bands the effect will usually be unimportant.

New Threat

The advent of colour TV on UHF threatens a problem for an area previously thought "safe." Front-end overload from an 80m. transmission can play havoc, as the chrominance sub-carriers on 4.43 MHz approximately are not far removed. No doubt a solution will be found, but the frequencies are too low to think in terms of stubs.

The new Telequipment Type CT71 transistor curve tracer is a dynamic tester for measurement of the characteristics of transistors, FET's and diodes, with direct presentation of a wide range of semi-conductor devices. Diodes can be checked at up to forward currents of 2 amps and reverse voltages of 1 kV.

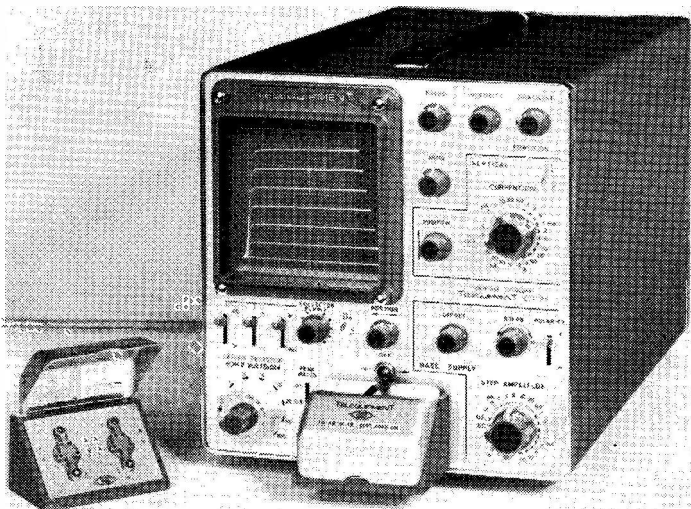

THE MONTH WITH THE CLUBS

By "Club Secretary"

(Deadline for April issue: March 10)

(Please address all reports for this feature to "Club Secretary," SHORT WAVE MAGAZINE, Buckingham.)

MANY a time in this space, we have talked about the old tendency in a Club for all the work to be done by a few people. However, this time round, let us look at it from a different angle: We can take it as read that pretty well all Clubs have this problem. However, there are those groups who carry on happily but just a few who, obsessed with the fact that they have a "silent majority," are constantly upbraiding the membership for not being more responsive. Two Clubs in particular spring to mind, where the newsletter complains of lack of active support every month—and in such terms that one gets the impression of a committee of dismal jimmies, to be avoided at all costs.

By all means bring up the subject at the AGM, or occasionally in the newsletter—but keep your views to yourself for the rest of the year. If, to a newcomer, the attitude seems to be happy with the present but looking for improvements, he will join; but if he feels that there is a lot of grouching going on, he will feel unhappy and not join; or if he has joined, he will cease to attend. And who could blame him?

The News

Some groups are for ever changing their venue; others seem as safe as the Rock. Your conductor would, from their newsletter, have unhesitatingly placed **Purley** in the second category—but after *sixteen years* in the same hall, they got just ten days' notice to quit. One can imagine the consternation—but they managed to find another place at reasonable rent, namely the Landsdown Hall in Lansdowne Road. This has resulted in a change of meeting night to Tuesdays—March 7 for a Natter Nite, March 21 for the Spring Junk Sale.

The **Cheltenham** Group have a pleasant little news sheet circulated monthly, which not only keeps the lads *au fait* with what goes on in the following month, but—and this is an idea worth copying—also a note of the new items on the market of interest to radio amateurs. They meet on the first Thursday every month, at their Club room at the Royal Crescent Hotel, Clarence Street.

From another **Cheltenham** source—G8DUH of the local Amateur Radio Society—we get the answer to the query here last month, on p.752. It seems that there are not three but *four* Clubs down there: The original one is the A.R.S., a pre-War foundation started many years ago (as we know) with its own callsign G5BK. Then there is the RSGB Group, apparently a breakaway from the Amateur Radio Society after some kind of internal

disagreement; there have been several attempts to reunite these bodies, so far without success. The third party is the Club centred on the Hq. of the Govt. Communications centre (callsign G3SSO) membership of which is confined to those working at G.C. Hq. The fourth group is the Cheltenham Grammar School radio society, for senior boys who are licensed amateurs (they were strong enough to take part in the 1969 MCC, gaining a very creditable place). Anyway, we now know how the Cheltenham area is organised in the radio amateur sense!

Another group notifying a change of venue is at **Burnham Beeches**—the new Hq. is at Hedgerley Scout Hut, where the routine is first and third Thursdays each month; thus March 2 is down for a talk on Transmission Lines by G3OHX, and the 16th for an evening of Morse Practice and operating the club station, G3WIR.

Only one date this month is notified by **Brighton Technical College**, namely March 12, when G3XUS is booked for a "Pot-Pourri on VHF/UHF." They re-open after the Easter vacation on April 10, continuing every fortnight.

Again we are to report a Junk Sale—this one is at **Southgate**, on March 9, at the Civil Defence Hut, Bowes Road, opposite Arnos Grove Tube station.

The **Thames Valley** crowd report their Annual General Meeting, taken in January, going on to say that their March session, on the 1st, will be devoted to Ships' Aerials and their problems. One would think this should attract the Top Band merchants with small gardens.

To try and encourage more activity in their part of the world, **Spalding** are organising a Counties Contest, and a Tulipland Award. Details from G3VPR, whose home is the venue for the meeting on March 17.

* * *

From **West of Scotland**, the hon. secretary complains he has not had a mention of late—but if we don't receive the information we can't mention! Seriously, though, every Club report that comes in by the deadline *is* given a mention, or if too late is kept for the following month. All secretaries should note the deadline (regularly given in advance) and take care that their news arrives on time. However, to revert to the programme, West of Scotland are now probably the biggest group in Scotland, supporting a speaker at every weekly meeting. These are on Fridays, details obtainable from GM3VTB, address as in Panel p.52.

At a recent Cheltenham Group meeting, a demonstration was given on how to get a half-wave aerial on Top Band, using a kite. There is a good deal more to it than you might suppose!

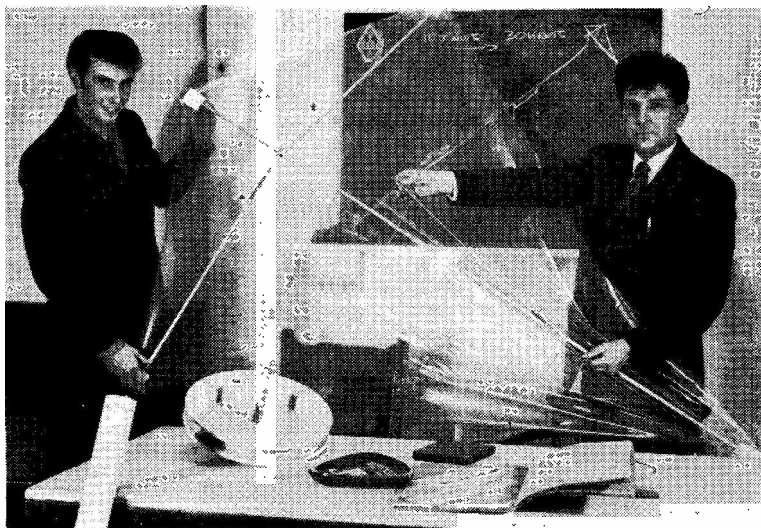

Down South again, to the West Country in fact, where **Salisbury** are thriving on a diet of a technical talk once in each month, the other evenings being mainly devoted to the completion of the conversion to make their own clubroom at the Old Saw Mills, South Street, Wilton. Any Tuesday evening will find them there.

Still in the South-West, we turn now to **Yeovil**, who are at the Youth Centre, 31 Park Lodge, each Thursday. The tape-lecture this month is on March 2—Basic Valve Circuits.

The **British Amateur Radio Teleprinter Group** write to remind us, and hence readers, that they are having a Convention on May 20, at Meopham Village Hall, near Gravesend. They hope to have live RTTY stations on the HF bands and VHF, trade stands, and lecture/demonstrations of their speciality.

A change in the arrangements is notified by the hon. sec. for **Worcester**, who notes that meetings are held on the first Monday and the third Saturday, at the Crown Hotel Broad Street. On March 6 they will be listening to G3III, who will talk about the business of Air Traffic Control, but there is no formal detail on the March 18 session.

Nice to hear again from the **Mid-Herts** group—they next foregather on March 9, at Welwyn Civic Centre, for a Constructor's Competition and Film Show.

In the "Midlands conurbation," as the planners call the area centred on Birmingham, there are several radio amateur groups. One of very long standing is the **Slade Radio Society**, who are in Church House, High Street, Erdington, on March 10 and 24.

South Manchester next; they have their "full" meetings on Fridays—3rd for "Frequency Meters and Measurement"; the 10th for a Mobile Forum; 17th, to discuss the operation of the Yaesu FT-101; and the 24th, when G8DKE will talk about Nuclear Power. (Of course, March 31, being the Bank Holiday, is missed.) Other sessions are on Mondays, when the VHF group get together. Main meetings are at Sale Moor Community Centre, Norris Road, Sale, the VHF gatherings being

at "Greeba," Shady Lane, Manchester 23, where they can use the Club shack.

There is positive evidence that Club Secretaries are born, not made—a fact of which we have always been aware! For instance, G3PSP used to report to us for the Lothians and Heriot-Watt University Clubs. He now re-appears as hon. sec. of **Edgware**, to advise that they foregather at St. Georges Hall, 51 Flower Lane, Mill Hill, on the second and fourth Mondays of each month.

A house at the rear of the White Horse Hotel, 83 Armley Town Street, Leeds 12, is now the Hq. of the **White Rose** crowd; they have torn the place apart and virtually rebuilt it to their own requirements, with a workshop, operating room, committee room, kitchen (and a "TV lounge"!) available to members at almost any time, although regular Club meetings are on Sunday mornings and Wednesday evenings.

March 9 and 23 are the next dates for **North Kent**. The first of these is a Project Evening, when those who have made their "Puff Boxes" (capacity testers) will be able to calibrate them, and discuss the nest project. The second date in March is for a Mullard Film Show; both dates are at the Congregational Church Hall, Chapel Road, Bexleyheath.

March 1 is down for the **Reigate** group, with some Crawley Club members as judges for their Constructional Contest. For this event they use Nutley Hall, Nutley Lane, Reigate, but for the informal on the third Wednesday, the place is the "Marquis of Granby" in Hooley Lane, Redhill—2030z in the saloon bar, to be exact.

The **Wirral** boys seem to be recovering from the "slings and arrows of outrageous fortune," so that they can now press on—on the first and third Wednesdays of each month, at the Sports Centre, Grange Road West, Birkenhead.

* * *

On the front page of the current issue of their *CQ-TV Magazine*, there is a very fine picture of the signal

received from G6NOX/T in Saffron Walden. Inside, there is much material of interest to A/TV fans—who those who aspire to transmit and receive TV in the amateur context.

Our next stop is at **Cornish**, who have March 2 at the SWEB Club Room, Pool, Camborne, for G3NKE to talk about the Club awards, followed by Geoff Hubber on Radio Controlled Models. We can also give advance warning that April 6 is the AGM.

Unlike most other clubs, **Solihull** have their "informal" earlier in the month than the main meeting. The latter, at the Manor House, Solihull on March 21, is a Mini-Junk Sale, after which G3NXC will talk about Test Equipment; the informal is at the Malt Shovel, High Street, on the 7th.

Of the five dates in March for **Coventry**, the 3rd, 17th and 31st are all nights-on-the-air. That leaves the 10th, for a Beginners' Question Night, and March 24 when it is hoped to visit the Meteorological Observatory,

Waterworks Road, Edgbaston, Birmingham.

Thornton Cleveleys feature the G3VNX/G3TNN OM/YL pair, to talk about Certificate Hunting on March 1. Then on March 15 comes a Hot-Pot Supper. Both are at the St. John Ambulance Brigade Hq., Fleetwood Road North, Thornton.

The place to find the **Hull** lads each week is 592 Hessle Road. March 3 is to be devoted to the vexed question of "Build or Buy?" while on the 10th G3OHT says his piece about Modern Filters. March 17 is set apart for SWL Spence to discuss a "simple valve receiver for less than five pounds," and on March 24, G4LH has the floor, for his talk on Integrated Circuits. Since March 31 is Good Friday there will be no meeting.

Shefford is well "out in the sticks" but there always seems to be something doing there—as for instance in March, when on the 2nd G3XTQ will lecture on Mini-Computers, followed on March 9 by the first of their series of planning meetings for NFD. On March 16 it

Names and Addresses of Club Secretaries Reporting in this issue :

ACTON, BRENTFORD & CHISWICK: W. G. Dyer, G3GEH, 188 Gunnersbury Avenue, London, W3-8LB.
 BEDFORD: J. Bennett, G3FWA, 47 Ibbett Close, Kempston (2247), Bedford.
 BICESTER: T. H. Shaw, G8EWS, 5 Langford Gardens, Bicester, OX6-8NA.
 BORDER: C. H. Crook, G3YOG, 19 Hatters Lane, Berwick-on-Tweed.
 BRIGHTON (Technical College): R. J. Henley, G2CMH, 35 Wilmington Way, Brighton, BN1-8JH.
 B.A.R.T.G.: G. P. Shirville, G3VZV, 2 Bradford Way, Toddington (2740), Dunstable, Beds.
 B.A.T.C.: J. Rose, G6STO/T, Pinchbeck Farmhouse, Mill Lane, Sturton-by-Stow, Lincs. (042-776 356).
 BURNHAM BEECHES: I. MacHardie, G3YMV, 17 Blandford Road South, Langley, Slough.
 CHELTENHAM (A.R.S.): P. W. Legg, G8DUH, 4 Linworth Road, Bishops Cleeve, Cheltenham, Glos., GL52 4PB.
 CHELTENHAM (Group): E. Janes, G2FWA, Hillside, Bushcombe Lane, Woodmancote. (Bishops Cleeve 2229.)
 CHILTERN: P. Perkins, G3OUV, Fair Acre, Priory Road, High Wycombe (21612).
 COVENTRY: C. Jaynes, 20 Belgrave Road, Wyken, Coventry.
 CORNISH: J. Farrar, G3UCQ, Elm Cottage, Ventonleague, Hayle.
 CRAWLEY: G. Bowden, G3YVR, 51 Leighlands, Pound Hill (3253), Crawley, Sussex.
 CRAY VALLEY: P. F. Vella, G3WVP, 78 Hurst Road, Sidcup, Kent.
 CRYSTAL PALACE: G. M. C. Stone, G3FZL, 11 Liphook Crescent, London, SE23-3BN. (01-699 6940.)
 DARTFORD HEATH: Mrs. M. Worbey, G3XVC, 13 Havelock Road, Dartford (22889), Kent.
 DERBY: 5 Uplands Avenue, Littleover, Derby (21931), DE3-7GE.
 ECHELFORD: R. Hewes, G3TDR, 24 Brightside Avenue, Laleham-on-Thames, Middlesex (Staines 56513).
 EDGWARE: A. J. Masson, G3PSP, 62 Coldharbour Lane, Bushey, WD2-3NY.
 FARNBOROUGH: J. F. Akam, G8BIH, 9 Yellowhammers, Wooteys, Alton (82739), Hants.
 GREENFORD: J. A. Hedges, G3MMQ, 35 Ferrymead Avenue, Greenford, Middx.
 HEREFORD: S. Jesson, 181 Kings Acre Road, Hereford (3237).
 HULL: Mrs. M. Longson, 4 Chester Road, Wold Road, Hull, HU5-5QE.
 KEELE (University): V. J. Reynolds, Dept. of Communications, Keele University. (Keele Park 371, Ext 128).
 MANCHESTER: A. B. Langfield, G3IOA, 201 St. Marys Road, Moston, Manchester 10, M10 0BN. (061-681 5406.)
 MID-CESHIRE: Hon. Secretary's QTH wanted.
 MID-HERTS: D. Storey, G8CYX, 70 Ventnor Drive, Totteridge, London, N20-8BS. (01-445 6757.)
 MID-SUSSEX: E. Letts, G3RXJ, 87 Meadow Lane, Burgess Hill (3552), Sussex.
 NORMANTON (Grammar School): D. Lockwood, 7 Northfield Road, Sharlston Common, Wakefield, WF4-1AG.

NORTH KENT: M. Lee, G8EJH, 46 Harman Drive, Sidcup, Kent.
 NOTTINGHAM: M. R. Harris, G3VUI, 20 Durham Crescent, Bulwell, Nottingham, NG6-9AH.
 NUNEATON: D. W. Smith, 2 Niton Road, Nuneaton.
 OTLEY: H. S. Johnstone, 12 Rumble Croft, Newall Carr, Otley (2850), Yorkshire, LS21 2RE.
 PLYMOUTH: S. E. Martin, 32 East Park Avenue, Mutley, Plymouth, PL4 6PE.
 PURLEY: A. Frost, G3FTQ, 62 Gonville Road, Thornton Heath, Surrey, CR4-6DB.
 R.A.I.B.C.: Mrs. F. Woolley, G3LWY, Woodclose, Penselwood, Wincanton, Somerset.
 REDDITCH: R. J. Mutton, G3EVT, Summerhayes, Mill Lane, Oversley Green (Alcester 2041.)
 REIGATE: D. Thom, G3NKS, 6 Bracken Close, Copthorne (2165), Crawley, Sussex.
 SALISBURY: R. A. Titt, G3CMJ, Royston, Middle Winterslow, Salisbury.
 SALTASH: I. C. Aldridge, G4AJU, 302 St. Peters Road, Manadon, Plymouth, PL5-3DU.
 SHEFFORD: A. Sullivan, G2DGF, 12 Glebe Road, Letchworth, Herts.
 SLADE: J. E. Drakeley, 186 Conway Road, Chelmsley Wood, Birmingham 37.
 SOLIHULL: A. W. Bagley, G3XPY, 266 Warwick Road, Olton, Solihull.
 SOUTH BIRMINGHAM: R. J. Thompson, 23 Fox Hill, Selly Oak, Birmingham 29.
 SOUTHDOWN: A. Seabrook, G3ZQB, 6 Harebeating Gardens, Hailsham, Sussex.
 SOUTHGATE: J. Batchelor, G3XMV, 22 Faverham Avenue, Bush Hill Park, Enfield, Middx.
 SOUTH MANCHESTER: D. Holland, G3WFT, 7 Alcester Road, Sale, M33-3GW.
 SPAIDING: R. Harrison, G3VPR, 38 Park Avenue, Spalding, PE1-1QX.
 STAR: T. Leeman, G8BUU, 115 Asket Drive, Seacroft, Leeds.
 STRATFORD-ON-AVON: J. Webb, G3OOQ, 14 Townsend Road, Tiddington, Stratford-on-Avon (5973), Warks.
 THAMES VALLEY: C. B. Seaman, G3ATF, 40 Park Road, Ashford, Middx.
 THORNTON CLEVELEYS: R. Bellerby, G3ZYE, 4 The Cop, Rossall School, Fleetwood, Lancs.
 TORBAY: Mrs. G. L. Western, G3NQD, 10 Truro Avenue, Torquay.
 VERULAM: H. Young, G3YHY, 93 Leaford Crescent, Watford, Herts, WD2-5JQ.
 WEST OF SCOTLAND: V. T. Budas, GM3VTB, 28 Kelvinside Gardens, Glasgow, G20-6BB.
 WHITE ROSE: R. Nettleton, G3YED, 129 Stainbeck Lane, Leeds, LS17-2EB.
 WIRRAL: A. Fisher, G3WSD, 34 Glenmore Road, Oxton, Birkenhead. (051-652 5078.)
 WORCESTER: B. A. Jones, G8ASO, 12 Woodside Road, Larkhill, Worcester (29208), WR2-4NU.
 YEOVIL: D. L. McLean, G3NOF, 9 Cedar Grove, Yeovil.

White Rose Radio Society are now in new premises, with a separate operating room and gear for all bands, including two metres. In this picture, from far left, are G3ZSA, G3ZTU, G8EHV (president) and G3ZKH (near right). The 2m. station, with a 10-ele beam, is on the air every Wednesday evening from 7.30 p.m., under their own callsign G3XEP.



will be the turn of the SHF bands to be scrutinised—lecturer not stated. That leaves March 23, and on this evening R.A.E. Questions and Answers will be the topic.

The *Cray Valley Newsletter* takes on a new appearance for the start of 1972. One of the first things we note is that negotiations are in hand for another Hq., somewhere they could set up a permanent station. This being so, it would be best, if you want to look in on them during March, first to contact G3WVP, at the address given in the Panel opposite.

Back up North, this time to the **Star Club** in Leeds, meeting in their new Hq. at the New Inn Hotel, Bramley Town Street, every Wednesday evening. This group are very interested in going out VHF /P and indeed reckon to be out and about on the first Sunday each month. As for the HF bands, a station covering them is in the programme for as soon as funds allow.

Unless it falls on a Bank Holiday, **Southdown** are always booked at the Victoria Hotel, Latimer Road, Eastbourne, on the first Monday in the month. Thus on March 6, G2MI is to give a talk, and on April 10 there will be Junk Sale.

Redditch have for long had their meetings at the Old People's Centre in Park Road, where on March 9 they have a Natter Nite and on the 23rd a Night on the Air.

A first time of writing it is for **Normanton Grammar School**. The boys get together on March 14 for a talk on Hi-Fi, and on the 28th for their AGM. As they have, as yet, no licensed amateurs in the Club, a visit from a licensed type would be very welcome indeed. The venue is Room 22, and the Grammar School is in Church Lane, Normanton, about four miles out of Wakefield. Give them a look-in if you are within reach—QTH hon. Secretary in Panel.

We notice that in the latest list, **RAIBC** are no longer distinguishing between their blind and invalid categories of membership—but they could always do with more supporters, those people who make this Club the immense force for good that it is. "Supporting" can mean anything from an occasional visit to someone who cannot get out; taking an invalid or blind member with you when you go to a Rally; providing transport for a receiver donated by someone in Scotland to the place where it will be serviced up to scratch, or taking it from the latter place to its new owner—and hundreds of other similar tasks. Just drop a line to G3LWY, and she will enrol you and tell you your subscription; and when she has a job for you, she will let you know—while in the meantime you will have the pleasure of reading the monthly copy of *Radial* or taking part in the Club nets.

The report from the **Dartford Heath D/F Club** just missed our last deadline—but they got their mention just the same because we received their *Compass Points* the previous month. Anyhow, this is a family sort of Club, having their regular meetings and, of course, they go transmitter-hunting as often as they can.

Temporarily, the **University of Keele** group is a bit thin in numbers, laments G3COY, who hopes there will be more licensed types in the 1972 intake. However, before then, they will be running, in conjunction with the North Staffs group, a special-activity station on the occasion of the Open Day on April 22. Details from G3COY, QTH as in Panel, p.52.

We don't seem to have the latest information of the **Hereford lads**—not surprising as they have just passed their AGM as this is being written. Nonetheless, we can say that they get together on the first and third Friday in each month, in the Civil Defence Hq., Gaol Street, and that they are having a membership campaign.

SHORT CLUB NOTICES

| CLUB NAME | HEADQUARTERS LOCATION | MEETING DAY MONTHLY |
|-----------------------------|---|------------------------------|
| Acton, Brentford & Chiswick | 66 High Road, Chiswick | March 21 |
| Bedford | "The Dolphin," Broadway, Bedford | Thursdays |
| Bicester | 11 Stonebidge Crescent, off Bucknell Road | Fridays |
| Border | Tweed View Hotel, Berwick-on-Tweed | Last Sunday |
| Chiltern | Ernest Turner factory | March 14, 29 |
| Crawley | Church Hall, Ifield | March 22 |
| Crystal Palace | Church Hall, Barry Road, East Dulwich | March 18 |
| Derby | 119 Green Lane, Derby | March 1, 8, 15, 22 (AGM), 29 |
| Echelford | St. Martins Court, Kingston Crescent, Ashford, Middx. | March 13, 30 (AGM) |
| Mid-Cheshire | <i>not stated</i> | March 1, 8 |
| Mid-Sussex | Marle Place, Leylands Road, Burgess Hill | March 9, 23 |
| Nuneaton | Room 43, Nuneaton Tech. College | 1st Tuesday |
| Plymouth | Virginia House, Bretonside | 1st and 3rd Tuesdays |
| Saltash | Burraton Toc H Hall | 1st and 3rd Fridays |
| South Birmingham | Hampstead House, West Heath | March 1 |
| Verulam | St. Albans Town Hall | 3rd Wednesday |

N.B.—In each case, Secretary's name and address appears in Panel, p.52.

From past experience we can also say that they do try to run an organised programme for their meetings.

At **Stratford**, we see from their newsletter that everything is cut-and-dried right through till mid-June. March 3 is a Brains Trust and on March 17 Les. Higginbotham will talk about his activities in the South Pacific as VR2FT. Looking forward a little, the Club has secured a prime spot for their stand at the National Town and Country Festival, August 26-27 at the Royal Showground. Incidentally, we are talking of Stratford-on-Avon, not East London!

At **Farnborough**, the gang meet on the second and fourth Tuesdays of every month, at the Railway Enthusiasts' Club, 310 Farnborough Road, and there is usually something going on.

A change of secretary at **Greenford**, where G3OHX has found it necessary to stand down and is replaced by G3MMQ. The latter tells us that on March 3 there is a Junk Sale, on the 17th a series of Twenty Questions, the 31st being scrubbed as it is Bank Holiday.

Lots of information in the letter from **Nottingham's**

Secretary, who reports that the events are all at Sherwood Community Centre, Mansfield Road. March 2 is a "Forum"; March 9 a talk on "Chassis-Bashing" by G3OMK; March 16 they are on the air with the Club station; March 23 will be a bring-and-buy Sale; and on March 30 there will be a film show. All this is leading up to the big event of the year, the AGM on April 20.

Torbay seem to be going great guns with their Tuesday meetings, although the Friday ones have been dropped for the present. On March 25, the members will converge on the Hq. in Bath Lane, behind 94 Belgrave Road, Torquay, to hear Mr. Heather and his recordings of "Hams on Tape" (*sic*).

From up in Yorkshire, **Otley** come into our picture again, with meetings arranged for Tuesday evenings at 14, Back Court House Street, to include lectures by guest speakers, film shows and a new item "Let's Talk About It", when a Club member takes the floor and discusses a piece of equipment he has constructed (and the snags that he had to overcome in getting it going).

The **Manchester** Group, with their own station signing G3HOX, meet at the Newton House Community Centre, 203 Droylsden Road, Newton Heath every Wednesday at 7.30 p.m. They offer Morse tuition by G3GB and their lecture programme includes, on March 8, "Activity in 4X4" by G3RTU, and "Aerials" by G2ALN on April 12.

Au Revoir

At this point we come to the bottom of a fat pile of reports from all over everywhere—keep 'em coming, with, next time, details of *April* activities, to arrive by first post **March 10**, addressed as ever: "Club Secretary," SHORT WAVE MAGAZINE, BUCKINGHAM, as clearly and legibly as you can, to make sure it will arrive. Till we meet again.

RACAL ANTENNAS, LTD.

Racal Communications, Ltd. have formed a new subsidiary company called Racal Antennas Ltd. The new company can advise on the most suitable types of aerial for a particular requirement and provide site surveys, lay-outs, installation and commissioning services. This is, of course, for commercial-user requirements.

"PRECLENE" SOLVENT

Electrolube, Ltd. have produced a new Aerosol solvent, *Preclene*, for the efficient removal of dust, dirt, grease and dried lubricants from electrical components and switchgear. Non-toxic and non-flammable, Preclene costs 63p the pack.

A direct subscription costs £3 for a year of twelve issues, first-class posting, starting any month. Orders to: Circulation Dept., Short Wave Magazine, Ltd., 55 Victoria Street, London, SW1H-0HF.

NEW QTH's

This space is available for the publication of the addresses of all holders of new U.K. call signs, as issued, or changes of address of transmitters already licensed. All addresses published here will be reprinted in the U.K. section of the quarterly supplements to the "RADIO AMATEUR CALL BOOK" in preparation. QTH's are inserted as they are received, up to the limit of the space allowance each month. Please write clearly and address on a separate slip to QTH Section.

EI6CH, B. Smith (*GW4ANO*), Kyleneashee, Rossmore, Woodford, Co. Galway. (Tel. Woodford 27.)
G3VFN, J. Gardner, 2 College Arms Close, Stour Row, Shaftesbury, Dorset. (re-issue.) (Tel. East Stour 446.)
G3ZDH, R. A. Dixon (*GM3ZDH*), c/o Gale, Glan-y-Mor, 21 Esplanade, Burnham-on-Sea, Somerset.
G3ZJU, D. E. Melton, 35 Lyndhurst Road, Highams Park, London, E.4.
GM4AFF, S. Cooper, 145 South Anderson Drive, Aberdeen, AB1 6JS. (Tel. 0224-36552).
G4AJN, S. G. Wheeler, 3 Crescent Avenue, Hornchurch, Essex.
GW4ANO, B. Smith (*EI6CH*), Cim Farm, Abersoch, Pwllheli, Caerns. (Tel. Abersoch 2415.)
G4ARE, Exeter Amateur Radio Society, Community Centre, 17 St. Davids Hill, Exeter, Devon.
G4ASR, D. Butler (*ex-G4ASR*), 10 Holly Hill, London, N.21 1NP.
G4ATM, F. L. Coldwell, L.D.S., R.C.S.Eng., 103 Harrington Avenue, Blackpool, Lancs., FY4 1QD.
GM4AUS, J. Macdonald, 7 Braehead Avenue, Linlithgow, West Lothian.
G4AVB, D. G. Simmons (*ex-G8FDP*), 17 Berry Road, Stafford, Staffs. (Tel. Stafford 55191.)
G4AVK, S. P. Ripley, Lamorna, Eastfield Lane, Grimoldby, Louth, Lincs.
G4AVN, T. N. Thompson, 11 Aidan Grove, Ellington, Morpeth, Northumberland.
G4AVO, R. J. Thompson, 19 Park Road, Lynemouth, Morpeth, Northumberland.
GM4AVR, R. C. Hockey (*9G1GT*), Rosaburn, Garelochhead, Dunbartonshire, G84 OEJ. (Tel. Garelochhead 225.)
G4AVS, R. C. Wilson (*ex-G8DUD*), 1A Queen's Road, Basingstoke, Hants.
G4AVU, P. S. Taylor, 52 Beaulieu Avenue, London, SE26 6PP. (Tel. 01-778 9741.)
G4AVX, A. Newman (*ex-G8CXC*),

93 Saterns Avenue, Milton, Portsmouth, Hants., PO4 8QJ.
G4AWA, R. T. Payne (*ex-G8BXT*), Flat No. 8, Bevere House, Bevere, Worcester, WR3 7EF.
GM4AWB, R. A. Macduff, 17 Larchfield Road, Bearsden, Glasgow, G61 1AP.
G4AWP, R. H. Parker, 235 High Road, Harrow Weald, Harrow, Middlesex, HA3 5EF.
G8EZM, N. R. Perrott, 1 Melbury Grange, Mavelstone Road, Bickley, Kent. (Tel. 01-467 6030.)
G8FAQ, R. G. Tyler, 26 Ridgeway Gardens, Redbridge, Essex.
G8FAR, R. J. C. Elms, 34 Ridgeway Gardens, Redbridge, Essex.
G8FLH, P. M. Smith, 7 Brentingby Close, Melton Mowbray, Leics., LE13 1ES.
G8FNV, L. P. Bushby, 49 London Street, Worthing, Sussex.
G8FOX, J. Bradshaw, 12 Errwood Road, Manchester, M19 2PA. (re-issue to *ex-G3BZC*.)
G8FQC, C. A. L. Riggs, 25 Laurie Crescent, Bristol, BS9 4SZ.
G8FQV, G. J. Thompson, 25 Meadow Avenue, Codnor, Derbyshire, DE5 4QN.

CHANGE OF ADDRESS

G3AAU, A. J. Hill, 33 Everest Road, Charlton Kings, Cheltenham, Glos., GL53 9LL. (Tel. Cheltenham 28431)
G3DUF, W. F. Poole, Moorcroft, The Greenway, West Hendred, Wantage, Berks. (Tel. East Hendred 466.)
GC3GPL, K. R. Davis, Haut du Pré, Fern Valley, St. Helier, Jersey.
G3LFB, P. H. Cosby, 4 The Firs, Stifford Clays, Grays, Essex.
G13LLQ, Queens University Radio Club, Queens University of Belfast, 37 Fitzwilliam Street, Belfast, 7.
G3LNT, J. R. Ambrose, 4 Bathurst Road, Staplehurst, Tonbridge, Kent.
G3NGC, M. Bell, 13 Birch Road, Wellington, Taunton, Somerset.
G3NKH, R. Dowling, 17 Lonsdale Meadows, Boston Spa, Wetherby, Yorkshire. (Tel. Boston Spa 842050.)

G3NPF, A. C. Wadsworth, 39 Church Road, Broadbridge Heath, Horsham, Sussex. (Tel. Horsham 66290.)
G3RJI, A. H. Paul, 14 Lamerton Road, Barkingside, Ilford, Essex.
G3RND, J. Berden (*G6AAR/T*), Gay Dolphins, Hilton Road, Gurnard, Cowes, Isle of Wight.
G3USP, J. R. Middleton, 49 Wolsey Road, Kingston Hill, Stafford.
G3WS, F. S. A. Jenkins (*VK2BFJ*), P.O. Box 240, Pennant Hills, New South Wales, 2120, Australia.
G3XEP, White Rose Radio Society, 83 Town Street, Armley, Leeds, LS12 3HD.
GM3XNE, A. F. Smyth, 4 Afton Place, Ardrossan, Ayrshire, KA22 8HN.
GM3XON, S. G. Casperd, 17 Pearce Avenue, Corstorphine, Edinburgh, EH12 8SW.
GW3XRZ, W. R. Mawston, Water Hayes, Spittal, Haverfordwest, Pems.
G3YI, D. Bawden, 2 Glenn Road, West End, Southampton.
G3ZPN, J. V. Gibson, 42 Bursall Square, R.A.F. Patrington, Hull, Yorkshire, HU12 0QQ.
G6AAR/T, J. Berden (*G3RND*), Gay Dolphins, Hilton Road, Gurnard, Cowes, Isle of Wight.
G8AOV, P. Hiron, 50-A Avonmore Road, London, W.14.
G8AWR, M. J. Probert, Severn Lodge, Green Lane, Malvern Wells, Malvern, Worcs.
G8CUA, B. G. Capper, 49 Hawthorn Close, Takeley, Bishops Stortford, Herts. (Tel. Takeley 517.)
G8EVP, D. R. Dabinett, 1 Court Cottage, School Street, Drayton, Langport, Somerset.
G8FID, S. T. Heapey, The Uplands, 68 Somerville Road, Sutton Coldfield, Warks.

AMENDMENT

G4AUB, A. J. Smith, 46 Evington Parks Road, Leicester, LE2 1PR (incorrectly sent in as "G4ABU" for February issue).

"DX ZONE MAP"

In four colours, on durable paper for wall mounting, 35in. wide by 25in. deep. Giving essential DX information—bearing and distance of all parts of the world relative to the U.K., the 40 Zone areas into which the world is divided for Amateur Radio purposes, with major prefixes listed separately. Distance scale in miles and kilometres. Time scale in GMT. Marking of Lat./Long. close enough for accurate plotting. Hundreds of place names, mainly the usual ones, and most of the rare islands.

With new revised Prefix List

Price 85p

including postage and special packing in postal tube to avoid damage in transit.

Publications Dept.

Short Wave Magazine Ltd., 55 Victoria Street, London, SW1H 0HF (01-222 5341/2.)

G3ACQ OFFERS :—Components—Tech GDO's—Tech Signal generators—Standing Wave Bridges—Field Strength Meters—**SOLID STATE MODULES** Dual Gate Mosfet Converters. 2 metre, 4 metre 70 cm, all at £13-75. 2 metre preamps at £6-50. These are **TOP CLASS PERFORMERS** and I haven't heard better. TRIO 9R59DS, TS510, JR310. **CRYSTALS** 1-8 to 30 MHz amateur bands also 6-9-12-16-36-48-70 MHz for V.H.F., 65p post paid. **JOYSTICKS** and Tuners.

S. MAY (Leicester) LTD.

12/14 CHURCHGATE, CITY CENTRE, LEICESTER LE1 4AJ.

Telephone: 58662

DERWENT RADIO

SHOWROOM, 5 COLUMBUS RAVINE, SCARBOROUGH

| | | | | |
|-----------|--|---------|---------------------------------|----------|
| SCA 63982 | KW Atlanta VFO | £32.00 | Trio JR599 | £185.00 |
| | Wightraps, pair | £2.50 | Trio Tx 599 | £185.00 |
| | Wightraps hi power | £3.50 | Trio 9R59DS | £47.00 |
| | Hallcrafters SX 133 | £145.00 | Trio JR500Se | £65.00 |
| | Yaesu FT101 | £240.00 | Trio JR310 | £77.00 |
| | Yaesu FT401 | £215.00 | Trio TS510 transceiver | £180.00 |
| | Yaesu FL400 | £140.00 | Trio SP5D speaker | £4.00 |
| | Yaesu FR400dx | £120.00 | G Whip 160/80 | £9.00 |
| | Yaesu FR400S | £160.00 | G Whip Tribander | £9.00 |
| | Yaesu FT 200 and p.s.u. | £172.00 | G Whip basemount | £1.50 |
| | SP 400 speaker | £10.00 | Unica UR-1A rx. | £25.00 |
| | Miniature transistor choke | 5p | Halsion mobile whip | £7.50 |
| | Car radio tuner | 15p | Unica UNR 30 rx. | £14.75 |
| | variable L | 5p | TE15 GDO | £12.50 |
| | 5 ohm switched potentiometer | 5p | Halsion extra coils | £4.40 |
| | Panel mains neon | 10p | 250 ohm carbon pot. | 25p |
| | Mains rocker sw with neon | 20p | R5GB Logbook | 45p |
| | Microswitch | 5p | RCSB Callbook | 50p |
| | m.e.s. bulbholder | 1p | All R5GB Publications in stock. | |
| | 2 pushbutton w/change switch | 10p | Eddystone EC10 Mk. II | £74.00 |
| | Trimmers 10-140pf | 2p | EC10 mains psu | £7.75 |
| | Trimmers 4-40pf | 3p | Silver mica, mixed bag | 20p |
| | 240v. a.c. relay, double c/o | 30p | Ceramic capacitors mix | 20p |
| | Transistor o/p transformer | 10p | Wirewound resistors, mix | 50p |
| | 4 digit impulse counter | 30p | Diecast boxes | from 80p |
| | OC28 type heat sink 5 1/2" | 5p | Adcola Invader Iron | £1.70 |
| | OC71 type heat sink | 2p | Sentinel 2m Conv. | £13.75 |
| | Mains slide switch | 10p | Sentinel 70 cm. Conv. | £13.75 |
| | 10 crystals. Our selection | 80p | Codar 12/R/C | £2.50 |
| | 500 micro/a meter, round | 40p | Lafayette HA600 | £45.00 |
| | Small dc motor, 12v. | 40p | Lafayette HA800 | £57.00 |
| | Roller coaster, 5 1/2" | 75p | Jackson 25 pfd variable | 22p |
| | 5 mixed relays | 50p | TTC 5 band RF meter | £4.00 |
| | 6 b.a. bolts, one type or mix. 18p per 100, £1 per 1,000 | | TTC s.w.r. bridge | £2.20 |
| | 12v. ex govt. vibrator rectifier unit complete (2 vib) carr paid | £1.50 | TTC s.w.r. bridge | £7.20 |
| | In-line fuse holders | 2p | Amphenol PL259 ptfc | 30p |
| | Resistor 1/2w. | 2p | Amphenol SO 239 | 25p |
| | Chokes 10H 50 m/a | 20p | Amphenol reducers | 5p |
| | Xtals 3B-888 | 75p | Amphenol SO239A ptfc | 30p |
| | Mosfets 3N140 3N141 (RCA) | 85p | RCA 6LQ6 | £2.60 |
| | MFP 102 2N3819 | 40p | RCA 6GK6 | 95p |
| | OC170 AC187 AC188 | 25p | 6146 | £1.60 |
| | BF180 | 37p | HCGU xtal sockets | 5p |
| | BC109 2N706 | 10p | "J" Beam 2m halo | £1.30 |
| | Transistor equivalent manual | 40p | Shure 201 | £5.50 |
| | Tested transistor ccts. | 40p | Shure 444 | £14.00 |
| | Transistor ccts. manual | 15p | Acos Mic 45 | £1.10 |
| | Transistor ccts. for beginners | 40p | Magazine binders | 72p |
| | Radio servicing for amateurs | 20p | Valve and Transistor Data | 75p |
| | Guide to B/cast Stations | 50p | 2ft. telescopic aerial | 30p |
| | Wanted : We are always pleased to hear about your trade-in equipment and are looking for good KW, Eddystone, and TW items in particular. We can offer cash, or radio equipment in part exchange. | | All RCA publications in stock : | |
| | Pye base receiver low | £5.00 | Tx valve manual | £1.00 |
| | Trio JR500Se | £55.00 | Rx valve manual | £1.25 |
| | TS510 as new | £160.00 | Transistor manual | £1.30 |
| | Trio JR 310 mint | £65.00 | Transistor servicing | £1.70 |
| | Codar PR30X | £7.00 | Hobby ccts. manual | £1.05 |
| | Labgear LG300 | £30.00 | S.C.R. manual | 75p |
| | Central Electronics 100v. am/ssb/fsk/Tx | £150.00 | Power transistors | £1.00 |
| | Eddystone 840C | £45.00 | I.C. applications | £1.30 |
| | Vanguard hiband | £25.00 | Trio 9R59DS | £40.00 |
| | Trio TS500 & p.s.u. | £125.00 | Eddystone 840A | £35.00 |
| | Trio VFO-5 | £18.00 | KW 2000B and p.s.u. | £185.00 |
| | | | Swan Cygnet | £170.00 |
| | | | 1392 and p.s.u. | £15.00 |
| | | | Pair 100TH on chassis | £2.00 |
| | | | Hamgear PM2 | £7.00 |
| | | | Jan. bug key | £5.00 |
| | | | TE15 GDO | £10.00 |
| | | | HRO 50 rx | £60.00 |
| | | | AR88 Mains cap. | £2.00 |
| | | | HRO gangs | £2.00 |

LATEST : Plastic strip pockets to take 12 QSL cards for vertical wall display. One strip 3p, 10 strips 25p. Postage 6p. Complete calibrator kit for Trio 9R59D. All parts including 1 MHz crystal and valve, £4. Please add extra for carriage. S.A.E. lists.

28 Hillcrest Avenue, Scarborough, Yorks.

CHILTERN AMATEUR RADIO CLUB

INTEGRATED CIRCUIT MARKER GENERATOR

Provides marker points at the following frequencies : 1 MHz, 500 kHz, 100 kHz, 50 kHz, 10 kHz. Kit includes 4 ICs, Xtal, PCB etc., giving harmonics to over 150 MHz. Kit with full instructions £5-55 or ready built £6-25 post free. S.A.E. for further details.

THE TREASURER,

12 ROUNDLANDS, LACEY GREEN, AYLESBURY, BUCKS.

MARKHAM ELECTRONICS

Technical G3FPQ YAESU TRANSCEIVERS SALES XYL

All ex-stock—delivery free—12 months' guarantee excluding valves and semi-conductors—unbeatable value—our prices and H.P. rates are the lowest available.

| | |
|---|------|
| FT101: Ultra modern complete station—260w. P.E.P. input. Fully transistorised save for driver and P.A. Complete with microphone and built-in speaker | £225 |
| FT200: (Less P.S.U.), 260w. P.E.P. input. All usual operative facilities such as selectable USB/LSB, VOX, 100 kHz calibrator, clarifier ±5 kHz are included. A modern transceiver with YAESU quality. | £120 |
| FP200: AC power supply and speaker unit for FT200 | £35 |
| FTDX400: 560w. P.E.P. input. Similar to FTDX560 but no W.W.V. band and no provision for CW filter. Limited number only | £175 |
| FTDX560: 560w. P.E.P. input. W.W.V. band and provision for installing C.W. filter, selectable USB/LSB, VOX, 25/100 kHz calibrator, clarifier ±5 kHz, ANL and AC power supply all built-in | £180 |
| FTDX401: As FTDX560 plus built-in P.A. cooling fan, C.W. filter and sensational new noise blander unit | £205 |

FTDX400, FTDX560 and FTDX401 are all variations on the same basic design and represent unbeatable value for a high quality 560w. P.E.P. transceiver with built-in AC P.S.U.

MARKHAM OAK, BUCKS HORN OAK, FARNHAM, SURREY.

Telephone Bentley (Hants) 3168 (evenings)

G2CTV **G3ZY**

J. & A. TWEEDY (Electronic Supplies) Ltd.

SPECIALISING IN AMATEUR RADIO EQUIPMENT

KW ELECTRONICS LTD. Full range of KW equipment and accessories in stock.

| | | |
|-----------------------|---------------------------|---------|
| TRIO : | P.T.T. Hand mike ... | £3-36 |
| 9R59DS Receiver ... | JR310 Receiver ... | £77-50 |
| TS510 Transceiver ... | JR599 Receiver ... | £185-00 |
| | Other Trio accessories... | |

| | | |
|-------------------------|-------------------------|--------------|
| YAESU : | YD844 Table mike ... | £12-00 |
| FT101 Mobile/Fixed ... | FT101 wish top band ... | £255-00 |
| FT401 Transceiver ... | FT200 with psu ... | £172-00 |
| FLDX400 Transmitter ... | FRDX400 Receiver ... | £120 to £160 |
| FL2000B Linear ... | YD846 Hand mike ... | £5-00 |

EDDYSTONE RADIO EC10 Mk. II Receiver ... £79-00

MOSLEY AERIALS :

| | | |
|------------|------------------------------|--------|
| TA31JR ... | Atlas Vertical ... | £19-00 |
| TA32JR ... | TA33JR ... | £31-50 |
| | Ribbed Insulators ML5... ea. | 5p |

J BEAM AERIALS :

| | | |
|----------------------|----------------------------|--------|
| 2HO Halo ... | 70/14Y 14 el. 70 cm. ... | £6-45 |
| 2HM Halo ... | 2/8Y 8 el. Yagi ... | £3-80 |
| 2/10 10 el. Yagi ... | 2/14P 14 el. Parabeam ... | £13-00 |
| 2/12 double six ... | 70/16 double 8 70 cm. ... | £5-10 |
| | 70/18P 18 el. Parabeam ... | £6-50 |

ROTATORS CDR20 ... £20-00 CDR22 ... £25-00

TAVASU MOBILE AERIALS AS PREVIOUSLY ADVERTISED

Used Equipment :

| | | |
|-------------------------|-----------------------------|---------|
| Sommerkamp FTDX500 ... | Eddystone 940 ... | £95-00 |
| Sommerkamp FLDX500 ... | KW2000 Transceiver ... | £110-00 |
| Sommerkamp FL1000 ... | Trio TSS500 Transceiver ... | £110-00 |
| Yaesu FTDX400 ... | Hallcrafters HT44 Tx ... | £70-00 |
| Yaesu FL2000 Linear ... | Johnson viking linear ... | £45-00 |
| Eddystone EA12 ... | | |

HY GAIN AERIALS : 14AVQ £19 18AVT/VWB £33-00

ALSO OPEN IN THE EVENINGS BY APPOINTMENT AT "STONELEIGH," WADSHELF, CHESTERFIELD (4 miles from town on the A619).

OPEN TUESDAY TO SATURDAY, 9 a.m. to 5.30 p.m.

H.P. Terms available Part exchanges

64 Lordsmil Street, Chesterfield, Derbyshire

Tel. Chesterfield 4982 or 68005 Evenings

Interested in Leasing your equipment over 4/5 years and keeping up to date?

Write or get your dealer to write to:

G8KA

General Merchandise Credit Ltd.,

Cranbrook, Kent.

Minimum package deal £200.

H.P. Terms over 3 years also.

GM3BQA - WINTER BARGAINS

Marconi VHF high band mobile TX/RX type HP.113 complete with DC PSU and cables, etc., £20. Marconi TX strip HP 2 with valves good for 2 metres, £4.50. PSU for HP.82 incomplete, £1.50. Marconi PSU type 904 24v. DC input 250 DC output, £2.50. Marconi RX type TV5 less PSU, £4.00. Marconi selective calling RX, £5, less valves, £3. Marconi tone calling units 12 positions, £3. Marconi VHF aerial filters, £1. Marconi SSB Diversity RX type HR24 super jobs 3-28 MHz AC input as new tested crated, £100, complete as new, untested, £60. Val radio PSU 24 DC input 220v. DC and AC outputs 180w, £17 (will power your TV set, etc. during power cuts). Venner time switches, type 27746, £5. PSU 240 AC input 32v. 12A DC output, £8. A.T.E. Countryman VHF high band station 12v. DC consisting of transistorised RX and PSU, valve TX etc., superior job in one unit with handbook and circuit, £15. TX control panel with switches and lights, etc., £2. Control panel for battery charger less meter, £1. Aerialite PA3H dual TV amplifies 230v. AC CH.3, £4. Marconi mobile VHF TX type TPV 401 RX type H16J with speaker, control units and PSU and handbook, £10. PSU for B2 TX/RX 6v. DC and AC inputs, £6. Avo 47A in case, £6. Universal Avominor in case as new, £5. Telephone sets "L" as new, £4 each. VHF mobile TX/RX type 9AB tunable 12v. DC complete with internal speaker and hand set, £5. 60ft. telescopic tubular mast (U.S.A.) less guys, new crated, £20. 30ft. aerial mast kit complete with guys, new crated, £15. 10ft. triangular mast sections (U.S.A.) new, £7 each. Guys, turnbuckles, base plates, etc., available. VHF station complete TR1578B (like SCR522) 100-156 MHz including 12v. PSU control box, phones and mic, etc., crated, £22. Separate TX, £10. RX, £6. U.S.A. ATU's suit vertical or long wire as new, £4. Petrol generators up to 35v. DC at 1260w with control panel, new condition, crated, £30. 38 set TX/RX, £1.50. QQV0 3-10 QQV0 6-20A, 60p. KT66, 40p. Plus many more valves and gear. S.A.E. The VHF sets are less Xtals but would modify for 2 metres—carriage extra.

FORTH MOTOR CO.

EDINBURGH ROAD, COCKENZIE, EAST LOTHIAN.

Tel.: PORT SETON 331

MI-19467-A MASTER OSCILLATORS

These R.C.A. units which are used in the ET 4336 transmitter and which were supplied as a separate item, each in its own slide-in metal case, are ideal as the heart of any high-power transmitter, unmodified as a low-power (approx. 20w.) transmitter, or as a basis for modification to suit individual requirements. They incorporate a 6-position oscillator switch (covering 1 to 5 MHz); a 3-position Multiplier switch (covering 2 to 10 MHz); a D.C. current meter, and oscillator and multiplier coils with "turns counting" mechanisms for precise tuning. Power requirements are H.T. and L.T. for the 807 valve used in the unit, and are brought in by an 8-pin Jones plug on the rear of the chassis. The basic frequency coverage of the oscillator is 1 to 10 MHz, which can be extended to 20 MHz when used as the oscillator section of a higher power transmitter or when used on its own. All these and many more details are covered in full in the extremely comprehensive instruction/service manual (supplied with each unit) containing wiring and circuit diagrams, adjustments, photographs, etc. **BRAND NEW.** Price per unit is £8-50 including 807 valve. Carriage 75p.

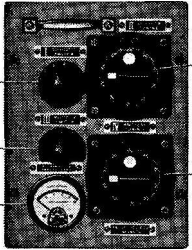

COLOMOR ELECTRONICS LTD.

01-743 0899 01-748 8006

170 GOLDHAWK ROAD, LONDON, W.12.

TRANSISTOR POCKET BOOK

by R. G. HIBBERD, B.Sc., M.I.E.E., Sen.M.I.E.E.E.

This addition to Newnes series of technical pocket books provides a comprehensive guide on the characteristics and use of the various types of transistor that have come into use in recent years. It is based on the junction transistor, fully taking into account the latest varieties including the epitaxial planar, field effect, metal-oxide silicon and thin film types. Earlier chapters describe the principles of operation, transistor characteristics, equivalent circuits and parameters and establishing suitable D.C. operating conditions. A chapter is included on the manufacture of transistors, so that the effect of the basic methods of fabrication and types of junction on transistor characteristics is clearly understood. The operation and characteristics of associated semiconductor devices used in conjunction with transistors, such as the junction rectifier, silicon controlled rectifier, zener diode, tunnel diode, varactor diode and phototransistor are also described. Low level, high power and high frequency amplification; oscillator, switch and D.C. amplifier circuits; radio receivers and power supply arrangements are all covered in separate chapters, practical circuits complete with transistor types and component values being included for these various applications. The book also includes notes on handling and testing transistors, and a chapter on solid state circuit techniques.

£1.55, post free

from: **SHORT WAVE MAGAZINE**
55 VICTORIA STREET, LONDON, SW1H 0HF

RADIO COMMUNICATION HANDBOOK

Fourth Edition of the
Original RSGB "Amateur Radio Handbook"

Price £3.15

(+ post and packing 35p.)

Available from stock

Order from

PUBLICATIONS DEPT.
SHORT WAVE MAGAZINE LTD.,
55 VICTORIA STREET, LONDON, SW1H 0HF

G3EKX S.S.B. PRODUCTS G3EKX**SPECIAL OFFERS****BRAND NEW GOODS**

- EDDYSTONE EB35 Mk. II Rx.** LW, MW, SW, VHF/FM coverage. One only left in stock £90.00
- NEW PYRAMID** Linear H.T. Transformers. 240v. 1/P. 1200v. 1 amp. Centre Tapped output. Less than 6 inches cube. Fully impregnated (Carriage £1.50) ea. £15.00
- NEW PYRAMID** Linear Filament Transformers. 6v. 12 amp O/P. 240v. 1/P. ... (P. & P. 75p) ea. £4.00
- 4 ONLY TRANSFORMERS.** 240v. 1/P. 0-12-15v. 3A. O/P ... (P. & P. 40p) ea. £2.50
- ONE SPHINX 3 BAND S.S.B. TX** (parts). Cabinet, printed/drilled panel, clean chassis, mains transformer, V.F.O. filter. All major parts. (NEW) only £30.00
- NEW V.F.O. 5.** As Used with TS500 Transceiver. (P. & P. 50p) only £20.00
- NEW DYNAMIC MIC'S.** Stick **DM18HL.** Low/High Z was £7.90, offered at £6.00
- DM16HL.** Low/High Z. was £6.80, offered at (P. & P. 20p) £5.00
- VICEROY Mk. 2.** S/Hand Tx. with power unit. Very clean ... (Carriage £2) £70.00

ALL LAST MONTH'S GOODS WE ADVERTISED IN STOCK.
HAVE ANOTHER LOOK PLEASE.

7 LITTLE CASTLE STREET, TRURO
Tel. **DEVORAN 862575** **CORNWALL**

SMALL ADVERTISEMENTS

("SITUATIONS" AND "TRADE")

5p per word, minimum charge £1.00. No series discount. All charges payable with order. Insertions of radio interest only accepted. Add 50% for Bold Face (Heavy Type). Box Numbers 12½p extra. No responsibility accepted for transcription errors. Replies to Box Numbers should be addressed to The Short Wave Magazine, 55 Victoria Street, London, SW1H 0HF.

TRADE

RALLY ORGANISERS: J. H. Associates, in co-operation with **Amateur Electronics, Birmingham (G3FIK)**, would like the opportunity of attending your Rally this season. We offer a very good selection of new and used equipment, together with a wide range of components. Your members' equipment can be brought to us for immediate sale or part exchange. Please let us have details as soon as possible.—**Jeff Harris, G3LWM**, Cricketfield Lane, Bishops Stortford, Herts.

STAY AT The Cornwall Ham-Radio Holiday Centre. Self-catering furnished accommodation. Six-element beam; 65ft. tower; 90 awards.—Full details from **Bernard Broughton, G3XBR**, St. Tudy, Bodmin, Cornwall.

QSL Cards and G.P.O. approved log books, hard back. Prompt delivery, stamp or large s.a.e. for samples, please.—**Atkinson Bros., Printers, Looe, Cornwall, PL13-1L3.**

TRIO EQUIPMENT: All models and accessories in stock for immediate delivery. No-deposit credit can be arranged with payment spread over two years. Cameras and such taken in part-exchange. We also stock Codar equipment, Joystick antennae and G-Whips for superior mobile performance. Good commercial amateur-band gear taken in exchange for Cameras or Hi Fi stereo apparatus.—**York Photo-Audio Centre, Fossgate, York. (Tel: 56176).**

QSL Cards. Two-colour. Attractive design, variable features, from £3-15 per 1,000 (inclusive). Send foolscap s.a.e. for samples.—**A.R.A. Press, 46 Moat Avenue, Green Lane, Coventry.**

QSL Cards for Tx and SWL. Send s.a.e. for samples stating which type required.—**Beaumont, G5YV, 8 Ashfield Avenue, Morley, Leeds, LS27-0QD.**

QSL Cards: for Tx, G8 or SWL. One to four-colour designs; large s.a.e. for samples; good selection.—**Red Rose Publicity (Pennington), 34 Aqueduct Street, Preston, Lancs.**

APRIL Issue: Appears March 30. Single-copy orders 25p, post free, to reach us by Tuesday, March 28, for posting on March 29.—**Circulation Dept., Short Wave Magazine Ltd., 16 Victoria Street, London, SW1H-0HF.**

GOVERNMENT Surplus Wireless Equipment Handbook: Contains circuits, data, illustrations, valuable information on British/U.S.A. receivers, transmitters, transceivers. Includes modifications to sets and test equipment. Surplus/commercial cross-referenced valve and transistor guide. Price £2.85, post/packing 15p.—**Myers (B), 112 Stainburn Crescent, Leeds, 17, Yorkshire.**

SPARES Available for R.C.A. AR88D and AR88LF receivers; send s.a.e. for list.—**Reynolds, 5 Headland Way, Lingfield, Surrey.**

M.E.C.L. III Counter Prescalers: Read direct to 200 MHz, 70 mV input. Compatible with 20 MHz counter, output 1/10th of input frequency. Price £72.50.—**CQS Services, 1 Coniston Close, Felpham, Bognor Regis (23603), Sussex.**

G3UTT, Tunbridge Wells now building up stocks of components for radio amateurs, including J-Beam Aerials, at Teleservice, 136 Camden Road, Tunbridge Wells, Kent.

MET Balloons at 65p, for balloon-supported verticals. Also 275ft. reels of aluminium wire at 55p. Post and packing included.—DeLaSalle, G3XHI, Larkfield, Jubilee Lane, Langford, Beds.

READERS ADVERTISEMENTS

2½p per word, minimum charge 50p payable with order. Add 25% for Bold Face (Heavy Type). Please write clearly, using full punctuation and recognised abbreviations. No responsibility accepted for transcription errors. Box Numbers 12½ extra. Replies to Box Numbers should be addressed to The Short Wave Magazine, 55 Victoria Street, London, SW1H 0HF.

READERS

EXCHANGE OR SELL: Eddystone S.750 receiver, with matching speaker and S-meter. New appearance and believed perfect. Sell or exchange for good Trio 9R-59DS receiver.—Box No. 5065, Short Wave Magazine Ltd., 55 Victoria Street, London, SW1H-0HF.

SALE: Components, including some "Radiospares" items, still available in Bradford area.—Ross, 20 Briar Wood, Wrose, Shipley, Yorkshire BD18 1NB.

FOR SALE: KW-2000B with AC/PSU, four months old, price £180. Will deliver 40 miles radius of Manchester.—Ring Greaves, G3TMZ, 0204-77701.

WANTED: Two-metre Tx/Rx or transceiver, must be in good condition; also beam rotator.—Ring Kermode, G8ESK, Bradford 45611.

SALE: K. W. Vanguard Mk.I Tx, coverage 160 to 10 metres, £18. Lafayette HA-230 Rx, £16.—Gardner, G3WEB, 11 Langdale Avenue, Ramsgate, Kent. (Tel. Thanet 51164).

WANTED: Collins 75S-3 series outer cabinet with lift-up lid, brand new or as new. Also Hy-Gain HT-18 vertical, with tilting base. **SELL:** Brand new unused Stolle de luxe rotator. Also National HRO-60 cabinet with fittings. Offers?—Box No. 5066, Short Wave Magazine Ltd., 55 Victoria Street, London, SW1H-0HF.

WANTED: Eddystone EA-12 or 940 receiver, in mint and unmarked condition. Full particulars, please.—Leyland, 12 Cross Street, Morecambe, Lancs.

SALE: Hallicrafters SX-140 amateur band receiver. In perfect condition, complete with auto transformer, phones, manuals and extension speaker, £35 or near offer.—Ring Neil, 061-437 4716 (South Manchester), after 6 p.m.

SELLING: K.W. E-Zee Match ATU, unused, £11. Two-metre Nuvistor converter with PSU, IF 28-30 MHz, £8-50. Four-metre FET converter, £5-50. Also Solartron regulated PSU type SRS-151A, 0 500 volts, £10. Send s.a.e. for details.—Rawlings, G5RS, 20 Hedgeway, Guildford, Surrey.

FOR SALE: CR-100 Rx, with 6BA6 RF stage and RF gain control, S-meter, separate transistorised noise limiter and manual. Checked and re-aligned, £20. Joystick VFA and LO-2 Joymatch ATU, as new, £10.—Turton, 18 Wychem Road, Hornchurch, Essex.

DISPOSING: Eddystone EC-10 Mk.II receiver, unrequired gift, condition perfect, seen Edinburgh.—Box No. 5070, Short Wave Magazine Ltd., 55 Victoria Street, London, SW1H-0HF.

Echelford Communications

11, BROADWAY,
KINGSTON ROAD,
STAINES, MIDDLESEX

Telephone: STAINES 54401

We have the following items in stock plus many more; why not send an S.A.E. for our list.

NORMENDE Globe Trotter PRO receiver, covers LW, MW and 11 Short Wave Bands including all amateur Bands 160-10M plus VHF Radio. A marvelous portable set with excellent performance and price, £97-50.

KW EZEE Match A.T.U., £13-65. DC/DC inverters 12v. input to power KW2000 series of SSB rig. with circuit and in wooden packing cases, £15-00 including carriage.

R.S.G.B. publication ex stock.

New electrolytic capacitors, 25 for £1-00 plus 10p post and packing.

A. G. Wheeler, G3RHF

Open 9-6 Daily

Half Day Thursday

G. W. M. RADIO LTD.

MURPHY MARINE SHIP TRANSMITTERS. 1-5 to 16 Mc/s. VFO or crystal. 40 watts RT or CV. Valves P.A. 3 5B/254M in parallel, modulation pair 5B/254M. Two panel meters. Size 13" x 13" x 14". Complete and clean but not tested. Less power supplies, £11 carriage paid. A few similar Pye units with same line up but 13" x 15" x 14" have calibrated VFO, same price.

AERIAL VARIOMETER TUNERS. Made for 19 set Mk III. New condition, £1-30, post paid.

REED RELAY inserts, 1-85" long (body length 1-1"). Diameter .14" to switch up to 500ma at up to 250v. D.C. Gold clad contacts. 63p per doz., £3-75 per 100, £27-50 per 1000, post paid.

100 kc/s. crystals, glass envelope on octal base, £1-25, post paid. S. G. Brown headphones, type "B" £1-45, post paid. 2 meter transmitter sub-units. Contain 2 x 6516, 2 x 6064, QV04-7 and TT15 valves, £2, post paid. Pocket Dosimeters, 15p, post paid. Meters 1½" dia. 500 microamps calibrated 0-10, 75p, post paid.

PORTABLE AERIAL MASTS. Fine quality 48ft. masts by Coubro & Scutton. 2" dia. aluminium sections, complete with 16 guys, pickets and all fittings. Unused and in "as new" condition in green canvas carrying bag, £20, carriage paid. Also available Erection Derrick kit containing 3 additional mast sections, ropes and pulleys, etc. to enable mast to be erected by fewer personnel, £5, carriage paid.

HYGROMETERS. Wet and dry bulb type, new, £1-25, post paid.

TRANSFORMERS. Used "C" core, 200-250v. to 230-0-230v. 260ma. 6-3v. 0-6a., 6-3. 6-0a., £2, post paid. Chokes "C" core 10h. 75 ma. 50p, post paid or 6 for £1-65, post paid. Unused Radiospares "Heavy Duty" 205-245v. to 350-0-350v. 150ma. 6-3v. 2-5a., 6-3 3a., 6-3v. 2a (tapped at 5v. 3-5a), £2, post paid. "Midget Output" 50p post. Used "C" core 0-115-180-240v. to 0-24-30-32v. 2a., £1-50, post paid. New Gardner potted 200-250v. to 12-7v. 2-5a., £1, post paid.

CAPACITORS, paper, 8uf 400v., 30p, post paid or 6 for £1-05, post paid.

All Receivers and Test Equipment are in working order at time of dispatch. Carriage charges quoted are for England and Wales only.

Telephone 34897

Terms: Cash with order

Early closing Wednesday

40-42 PORTLAND ROAD, WORTHING, SUSSEX

SPECIAL OFFER OF UNMARKED TESTED 2N 3055 SILICON POWER TRANSISTORS

30p each. 4 for £1.

STC. 50 MHz Silicon H.F. Power Transistor. 10 watt (TO 3 encapsulation) type BUY 10 at 60p each.

TEXAS 2G 306. Low noise Audio PNP Transistor, 10p each.
TEXAS NPN Transistor. 800 mW, 50 MHz, 80 volt type 2N 2193A (D1178), 12½p each, 5 for 50p.

STANDARD MIDGET. 25pf Air-spaced Pre-Sets, 8 for 30p, 16 for 50p.

OC 36 Mounted on Finned Heat Sink at 50p.

ADZ 11 Mounted on Finned Heat Sink at 50p.

2N 3055 Mounted on Finned Heat Sink at 50p.

3 Diodes 200 P.I.V. 12 amps each, Mounted on Finned Heat Sink at 50p.

All 4 items above are ex new and unused equipment.

Transistor Disc Ceramics 1-3pf 50v.w., 3-3pf 50v.w., 4-7pf 100v.w., 10pf 50v.w., 100pf 100v.w., 500pf 100v.w., 1000pf 50 v.w., .01uf 18v.w., .022uf 18v.w., .047uf 12v.w., .1uf 18v.w., .1uf 20v.w., .22uf 3 v.w. All types at 10 for 15p.

EDDYSTONE 1-5mH 4 Pole R.F. Chokes at 10p each.

100 assorted untested unmarked 400 mW, 1 watt, 2 watt Zeners mixed at 50p.

14 Pin Dual in Line NPN Transistor package containing one matched pair plus 3 Single Transistors. All 600 MHz untested with circuit, 5 for 50p.

X BAND GUNN DIODES at £1.50, J Band Gunn Diodes at £1.50.

Sub-Miniature 2 Pole 5 way 2 Bank Rotary Switches at 22½p each.

Sub-Miniature 100 PIV 5 amp Silicon Bridges at 50p.

BRANDED HIGH SPEED DUAL COMPARATORS in 14 Pin Dual in Line package with Data at 30p each.

COMMUNICATION SERIES of I.C.'s, untested with Data, R.F., I.F. VOGAD, AGC, Headphone Amplifier, Double Balanced Modulator, Mixer. All at 25p each.

V.H.F. Counters (Divide by 2) operating up to 500 MHz in 8 Lead TO5 Can. Price £1 with details.

BRIMAR 30c2-TI 5" Cathode Ray Tube at £2.

J. BIRKETT

Radio Component Suppliers,
25 THE STRAIT, LINCOLN.
Telephone: 20767

The NEW SAMSON ETM-3 SQUEEZE - KEYS

With SQUEEZE-KEYING you make such characters as C, Q, Y, F, L, AR, SK, etc. with fewer paddle movements.

● 4 Integrated circuits 6 transistors, 2 diodes. ● Use double-paddle for either Squeeze-keying or normal fully-automatic electronic keying as preferred. ● Built-in PSU. ● Constant I : 3 dash-dot ratio. ● Weight only 2½ lbs.

RETAINS the star features of the WELL-KNOWN SAMSON ETM-2—used by coast stations and big ships all over the world:—

● Watchmaker-assembled keying-lever movement. ● Silent reed relay (400v., 1A contacts). ● Sidetone. ● TUNE button.

BETTER EVEN THAN THE ETM-2—GET YOURS NOW!
£24.75 post paid U.K.

... and still going strong:—

SAMSON ETM-2 electronic keyer, £21 (£22.20 with mercury batts.).

SAMSON STA Speaker/Amplifier, for ETM-2/ETM-3, £2.75.

JUNKER PRECISION HAND KEY. Superb German straight Key made for professionals afloat and ashore. Free-standing—needs no fixing to desk. Hinged grey dust cover. Front and back contacts with click-stop gap adjustment. Key-click filter, £8.95.

BAUER KEYING LEVER AND PADDLE UNIT—for your own El-Bug. Compact enough to build in. Gaps/tensions adjustable
NEW PRICE, £2.75.

MODEL TTU RTTY CONVERTER/KEYER—All-in-one-box instant send-recv RTTY with a TX/RX and cheap surplus teleprinter, £115.

SSB 90° PHASE SHIFT NETWORK UNITS.

All items post-paid U.K. Catalogue SP5 describes these and other RTTY, VHF, SSB kits and units.

SPACEMARK LTD. 14 PICCADILLY,
MANCHESTER 1.
(Tel.: 061-237 0817)

SALE: Heathkit RA-1 amateur band receiver, coverage 10 to 160 metres, very good selectivity and sensitivity, with BFO, USB and LSB, and built-in xtal calibrator. Very little used due to new interest in Hi-Fi. Price £25, to be collected.—Littlejohns, 25 Ludlow Road, Ealing, London W.5. (Tel. 01-580 7372, Works).

SELLING: Latest model Trio 9R-9DS communications receiver (listed at £47) with matching Trio speaker (listed £4.38), new November 1971, very little used and in original packing, £40. Also R.107 receiver, complete with operating instructions and drawings, perfect working order, £10. Buyers to collect.—Goslett, Malthouse Cottage, Bramley, Surrey. (Tel. Bramley 3192).

OFFERING: R.C.A. AR88D Rx with matching speaker, 540 kHz to 32 MHz, in perfect condition, £35 or offer? Also R216 with PSU, VHF Rx covering 19 MHz to 158 MHz, excellent condition and ideal 2m.4m. rig, £40 or offer? Buyer collects.—Teakle, 17 Leamington Road, St. Annes, Lancs.

SALE: R.C.A. AR88LF receiver, £35. Pye two-metre Tx, £12. Good working order.—Power, Chapel Green, Fillongley (40147), Coventry, Warks.

SALE: Samson ETM-2 keyer with monitor speaker/amplifier, hardly used, £15 or offer.—Box No. 5071, Short Wave Magazine Ltd., 55 Victoria Street, London, SW1H-0HF.

SALE: Boot type "Ranger" Tx on two metres, £3.20A PA, £12. Dash "Ranger" Tx on 2m., less case, £8.50. Dash "Ranger" Tx on two metres, £10. "Handi-Ranger" Tx on 2m., £13. GEC radiotelephone, 3-20A PA, £11. Hudson Tx on 4m., £5.50. New 2-metre FET converters, IF's 2.4, 4.6, 28-30 MHz. (4 metres IF 2.2-7 MHz), £9.75. Crystals: FT-243 6073-333, 6075, 5850, 5875 kHz, 60p. Carriage extra, s.a.e. enquiries.—Raybold, 16 Brookbank Road, Gornal Wood, Dudley, Worcs.

SELLING: Trio TS-510 transceiver, CW filter, with PS-510 and remote VFO-5D, in mint condition, price £160 or near offer. Delivered reasonable distance. Details on request.—Hayes, G3JBU, QTHR or ring 0604-43020 (Northampton).

FOR SALE: KW-2000A with AC/PSU. Also AR-22 rotator and items of test equipment.—Donders, G3UXJ, QTHR, or ring Midhurst 2764 (Sussex).

SELLING: "Short Wave Magazine", volumes 20-26, bound, £1.50 each; R.S.G.B. "Bulletin" 1965/6/7, bound, £1.50 each. In perfect condition.—Ring Levitt, Burgh Heath, (Surrey) 55973.

SELLING: KW-160 Phone/CW Tx, £16. "Cannonball" 160m. SSB Tx, £23. Variac, 9 amps., £3.50. Heathkit GDO, AC, £10. Erskine D/B scope, £18.—Roberts, G3AQX, Cottage Farm, Wessington, Derbyshire. (Tel. Alfreton 2943).

FOR SALE: HW-101, with PSU, CW filter, £130 or near offer, Mohican GC-1U receiver, £30 or near offer. Both few months old. WANTED: CR-150 in good condition.—Tew, G3MEJ, QTHR.

WANTED: By collector, Cossor 41-STH or equivalent; any bright emitter valves; also early type Tx valve about ½ kW.—Box No. 5061, Short Wave Magazine Ltd., 55 Victoria Street, London, SW1H-0HF.

EFFECTS of the late G3SBH: Including BC-221, Sommerkamp FL-200B, watt meter, 813 and 832 valves, Collins TS-69AF frequency meter and astro compass. Lists for price of many items.—Spencer, G3ILO, 1 Field Lane, Cam, Dursley, Glos.

SELLING: G2DAF Mk.II Rx, 75% completed, many modifications, offers?—Gibson, A2 Main Building, U.M.I.S.T., Sackville Street, Manchester, or ring Central 3311, Extn. 621.

FOR SALE: K.W. Viceroy Mk.IIIA with extra filter, £80. Also 500-watt Linear with PSU, £30. (Gone transceiver).—Ring Templer, G3RDX, Woodbury 364 (Exeter).

SALE: Sony CRF-200 Global transistor battery/mains transportable, 23 bands including VHF, (list £361) accept £250. Deliver reasonable distance.—Ring Thornber, Blackburn 21399. (RNARS).

SELLING: Naval UHF receiver tuning 250-700 MHz plus amplifier/speaker and special aerial system, price £70, carriage extra, s.a.e. with enquiries.—Hayward, Sunnyfields, Lighthouse Road, St. Margaret's Bay, Nr. Dover, Kent.

EXCHANGE: MR.44 Mk.II amateur band Rx FOR Heathkit RA-1 or Eddystone EC-10, with cash adjustment as necessary. Additional RA-1 required for SWL; one needing attention considered. Will collect or deliver reasonable distance.—Wilson, GW3DSV, Pen-y-bont Post Office, Pen-y-bont, Oswestry, Shropshire.

FOR SALE: Creed 7B Teleprinter, (24 volt) with manual, £15. Creed Type 25 five-hole punch, with handbook, £10. Buyer collects.—Weedon, 19 Helmsdale Close, Romford RM1 4RS, Essex. (Tel. Romford 69770).

WANTED: High-grade general coverage valve-type communications receiver, tuning from LF to 30 MHz or so, preferably in two megacycle segments, Modes AM/CW/SSB. Must be in first-class condition and working order, with manual. The proper price paid for a receiver in this category. Details, illustration if possible, history and price asked, please.—Box No. 4932, Short Wave Magazine, 55 Victoria Street, London, SW1H-0HF.

ST-6 Fibreglass Printed Circuit Boards £5 per set, with full constructional details. Valves: 4CX250B, £3; 4X150A, £1.50 each, or four for £5; 5B/254M, £1.25; 5B/255M, £1. Philips PM3230 'scope, £120 or near offer. U.S.A.F. Version of Hallicrafters S.27, coverage 27-143 MHz, FM/AM, internal PSU, with handbook and spare valves, £17.50. RTTY distortion margin test set, with manual, £5. 1190 kHz FT-243 crystals, with base, as used in January "Short Wave Magazine". Digital Tone Generator. £1.00 each.—Ring Perkins, G3OUV, High Wycombe (0494) 21612.

SALE: Heathkit RF-1U Signal Generator, brand new and unused, £19. K.W. Low-Pass Filter, unused, PL259 sockets, £4. BXI geared hand winch for raising three-section Lattice Tower, new, £5. Carriage paid.—Lee, G5FH, QTHR, Tel: Highcliffe 5974. (Hants.).

SELLING: Heath SW-717 receiver and manual, kit built, brand new, thoroughly instrument aligned, £26. **WANTED:** Trio 9R-59DS receiver.—Cameron, 47 Moorway, Poulton-le-Fylde (6171), Lanes.

SALE: Trio 9R-59DS Rx, perfect condition, £38. Also Eddystone 840A, £32. **WANTED:** Eddystone 888A.—Milner, 38 Lime Grove, Grantham, Lincs.

INSIST ON VERSATOWER

Acclaimed as the World's leading telescopic tiltover tower in the field of radio communication
Models from 25' to 120'

Enquiries to
Western Electronics (UK) Ltd
Osborne Road, Totton, Southampton

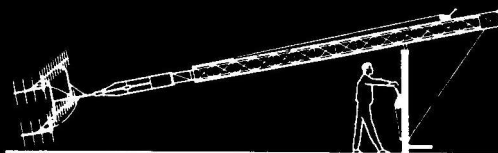

Look for the name

STRUMECH

Strumech Engineering Co Ltd
Coppice Side, Brownhills, Walsall, Staffs.

Listen to the world with Eddystone

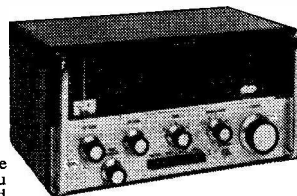

When you own an Eddystone communications receiver, you have the broadcasting world at your finger tips—wherever you happen to be—on land or at sea. The reputation these sets have attained is proof of their excellence and reliability and at Imhofs, there is a special Eddystone department where you can see, hear and compare the models listed here and some of the Eddystone professional receivers.

Same day despatch to any part of the world; free delivery in the U.K.; plus after sales service for which Imhofs and Eddystone are world famous.

EDDYSTONE EC10 Mark II transistorised communications receiver. A de-luxe version of this famous design now incorporating carrier level meter and limited fine tuner. £79.00.

EDDYSTONE 830/7 wide range communications receiver. A high grade HF/MF receiver covering 300 kHz—30 mHz in 9 ranges with crystal control facilities. Many satisfied users acclaim it as "the best ever". £372.75.

New from Eddystone—

EDDYSTONE EB37 transistorised broadcast receiver. Long, medium and shortwave coverage. Flywheel-loaded gear driven tuning. Self-contained battery pack for portable use. Accessory units available for 12/24v. D.C. and standard A.C. supplies. £98.00. (incl. £18.00 P.T.)

IMHOFS

MAIN EDDYSTONE
DISTRIBUTORS



Dept: 11/3

112-116 New Oxford Street, London, WC1A 1HJ Tel.: 01-636 7878

R 36H

HAMGEAR ELECTRONICS

PRESELECTORS

P.M. IIA This is a preselector covering from 1.8 to 32 Mc/s. in six overlapping ranges. Having a built-in antenna coupler to tune the antenna followed by a pentode to boost the signal up to 25 dB., before it reaches the Rx. With internal power supply, mains On/Off, indicator lamp and primary fuse. Price **£9.20**.

P.M. IIB This is a preselector with the same spec. as above, 1.8 to 32 Mc/s. and antenna coupler except it is solid state with an F.E.T. plus Bipolar. Price **£8.25**.

CALIBRATORS

Get acquainted with our calibrators:

P.M. IV 1 Mc/s. with 1,000 c/s modulation.

P.M. V 1 Mc/s. and 100 kc/s. with 1,000 c/s. modulation.

P.M. VIII 1 Mc/s., 100 kc/s. and 10 kc/s. with 1,000 c/s. modulation. This one has the ability to be tuned zero beat to a frequency standard transmission such as M.S.F.

Both P.M. V and P.M. VIII have integrated decade counters, nothing to go out of adjustment.

All the units are battery powered and as such are quite portable.

All give beats up to at least 30 Mc/s.

Priced at **£4.50**, **£6.50** and **£10.75** respectively.

Postage and packing, 25p.

2½p stamp for illustrated leaflets

29 CARLYLE ROAD, NORWICH

GRAHAM NEWBERY

(REG WARD G2BSW)

WE ARE OFFICIALLY APPOINTED K.W. AGENTS FOR THE SOUTH WEST (Somerset, Dorset, Devon, Cornwall)

| | |
|---|---------|
| KW Atlanta with p.s.u. | £210.00 |
| Remote VFO | £37.00 |
| KW 2000B with p.s.u. | £240.00 |
| Remote VFO | £39.00 |
| KW 202 Receiver | £140.00 |
| Matching Speaker | £6.00 |
| KW 204 Transmitter | £145.00 |
| KW 1000 Linear | £135.00 |
| KW 101 VSWR Meter (52 or 75 ohm) | £9.25 |
| KW103 VSWR Meter and Combined Power Meter | £12.50 |
| KW E-Z Match. 10-80m. ATU | £15.00 |
| KW 107 Combined E-Z Match, VSWR and R.F. Power Indicator, Dummy Load and Antenna Switch for 4 Outlets | £40.00 |
| KW Trap Dipole 70' 75 ohm Twin Feeder | £14.00 |
| KW Trap Dipole 97' Coaxial Feeder | £15.00 |

EDDYSTONE RECEIVERS

| | |
|-------------|---------|
| EC10 Mk. II | £79.00 |
| EA12 | £205.00 |
| 830/7 | £372.75 |

WE ARE THE DISTRIBUTORS OF EDDYSTONE PROFESSIONAL RECEIVERS FOR THE SOUTH WEST.

Trio Equipment Model 9R59DS £57.50

SECOND HAND EQUIPMENT in stock: Eddystone—940 General coverage Rx., £110; 680X, £65; 840C, £40; 840, £30; 888A Amateur Band Rx., £70. KW Vespa Mk. II Transmitter and p.s.u., £95. Codar AT5 Tx., T28 Rx. and A.C. p.s.u., £34. Lafayette HA600 General Coverage Rx., £38. Heathkit Mohican General coverage Rx., £25. AR88LF, £20.

SHURE MICROPHONES

| | |
|-----------|--------|
| Model 444 | £14.40 |
| Model 201 | £6.00 |
| Model 202 | £6.60 |

R.C.A. VALVES for KW and Heathkit equipment. 6146, 6146B, 61F5, 6LQ6, 6GE5, 6EA8, 6GW8, 6GK6, 6CM6, 6CL6, 6CB6, 6BN8, 61IS6, 6EW6, 12BA6, 12BE6, 12B26, etc. and many other types.

TRADE INS WITH PLEASURE. OUR STOCK OF GOOD SECOND HAND EQUIPMENT CHANGES DAILY - LET US KNOW YOUR REQUIREMENTS.

WE STOCK R.S.G.B. PUBLICATIONS, LOG BOOKS, Etc.
HP TERMS AVAILABLE

AXMINSTER — DEVON

Telephone: 3163

SELLING: New Heath GR-64 Rx, coverage 550 kHz to 30 MHz, with BFO, AGC, ANL, £18 or near offer.—Field, 53 Sunderland Road, Forest Hill, London, S.E.23. (Tel: 01-699 5206).

SALE: Mosley Commando SSB Tx, 180w. p.e.p., also AR88 Rx. Both unmodified and in mint condition, £90. H.P. available.—Ring Howell, G3JKI, Waterlooville 53853 day or Horndean 2756 evenings. (Hants.).

EXCHANGE OR SELL: Eddystone 770R, coverage 19 to 165 MHz in 6 bands; 19 Set for mains; several power supplies; Pye base station Tx minus PA and modulator—and all my valve stuff FOR: Good Eddystone EC-10 Mk.II.—Warman, G8COS, QTHR. (Tel: 0472-2254).

SALE: DX-40U Tx, with VF-1U VFO, £18. Also Lafayette KT-320 Rx, £18. Carriage extra.—Hardcastle, 13 Carlwell Street, London S.W.17.

WANTED: Ten-Tech PM2A transceiver in top-class condition at realistic price, with instructions.—Box. No. 5073, Short Wave Magazine, Ltd., 55 Victoria Street, London, SW1H-0HF.

FOR SALE: Panda PR-120V CW/AM Tx, in good condition, with spare valves, manual, etc.—Treece, G3QD, QTHR, Tel: Nottingham 257197.

EXCHANGE: Newnes "Radio and TV Servicing" in 13 vols., 1954 to 1965, as new, cost £50, OR Advance E2 Model 2 signal generator, as new, FOR CR-100, AR88D, Trio, or w-h-y?—Dodd, 88 Sandy Lane, Runcorn (73835), Cheshire.

SELLING: Trio 310 SSB Rx, as new, £63. Trio JR-60 Rx, 550 kHz to 30 MHz and 142 to 148 MHz, built-in calibrator and Q-multiplier, £45. Pye "Cambridge", new, £25. Pye "Westminster", new, £30. Pye Base Tx on two metres, £9. Tec-18 GDO, no coils, £5. CR-100, much modified, with built-in 'scope and calibrator, £9. Hudson FM-113H transceiver, with handbook, OK for two metres, valve Tx and transistor Rx, inverter PSU from U2's, £8. Buyers collect or pay carriage.—Sheedy, G8EWO, 24 Thornwood Road, London S.E.13 5RG.

WANTED: Inexpensive SSB Tx, e.g. Sphinx, Viceroy, M and G, HX-50, HT-37, G2DAF, etc.—Gent, 31 Warranton Road, Saltash (3413), Cornwall.

MANUALS: B.40, CR-150, RA-17, £1.75; R.1155, AR88LF, 75A, S.27, SX-28, Airmec 864, £1.25; SP.600JX, R.210, R.216, RA.137A, Collins J4, £2. Also R.206, Sets No. 19, 31, 52, 62, 88, 75p.—Brooks, 5 Farrant House, Winstanley Road, London, S.W.11.

APRIL issue SHORT WAVE MAGAZINE will appear on Thursday, March 30. Single copies at 25p post free can be supplied to orders reaching us by Tuesday 28th for despatch on Wednesday 29th, the day before publication. Orders with remittance to: Circulation Dept., Short Wave Magazine, Ltd., 55 Victoria Street, London, SW1H-0HF.

WANTED: Manual, circuit diagram or any details for Beulah Electronics TV camera D800. Loan or purchase.—Jess, Outspan, Quethiock, Liskeard, Cornwall.

OFFERING: Heathkit HW-30 two-metre transceiver, 240v., £20, or offer. Codar T.28 receiver, £12, or offer. Minimitter 2.7 transmitter, 25 watts, £15, or offer. **WANTED:** HRO Rx., also any 70 cm. equipment, would exchange foregoing.—Brown, G8FIK, 25 Newport Road, Wavendon, Blethley, Bucks.

SELLING: B.40, S-meter, 2m. and 4m. converters, £25. R.308 Rx for VHF, £15. Copy K.W. Valiant, with PSU, £20. Pye "Ranger", £5. Two-metre 6-ele, 4-metre 3-ele Yagis, Halo, £5. Also bits and pieces. Write or call evenings.—Bailey, G3PJB, 67 Birkbeck Road, Beckenham, Kent.

WANTED: B2 receiver, Tx and PSU. Also Eddystone EC-10 receiver (any condition).—Lewis, G3WBI, 6 Sydney Grove, Holmes Street, Hull, Yorkshire.

FOR SALE: AR88D receiver complete with trimming tools and spare set of valves, in immaculate condition both electrically and externally, with manual. Price £60 or near offer.—Ring Hornchurch 43676 after 6 p.m.

G3ZYC DISPOSING: 2-metre Base Tx, £20 or offer. 2-metre Cambridge Rx, tunable, £30 or offer. 70 cm. converters, £8 and £12.50, also 4-metre converter, £8 or offer. For SSB, AM, PM, Collins Multi-phase Exciter 20A, coverage 160-10 metres, ideal SSB source for VHF, with manual, £25 or offer. Two-metre 1000 and 70 cm. 1000 by Green & Davies, companion 2m. and 70 cm. 90w. transmitters, the pair £45. For 23 cm., triplers and converters; 70 cm. tripler, PA, solid-state modulators and various. Do not send cash yet, inquiries and offers, please.—Sneap, G3ZYC, QTHR, Ripley (0773) 3883.

FOR SALE: Heathkit HP-13A DC/PSU, £17.50. KW-101 75-ohm SWR meter, new, £9.50. Carriage extra.—Ring Market Harborough 5012.

FOR SALE: Eddystone 840C Rx, near mint, filter and mounting feet, £40. Heathkit GR-54 Rx, as new, factory aligned, £45 (list £77).—Gordon, 62 Drake Court, Lagland Street, Poole, Dorset.

WANTED: Alloy lattice mast, 20 to 30ft., also beam rotator, small modern monitor scope, FL-2000B Linear, Omega-T or similar, and rotary antenna switch.—Hodgkinson, G3NZT, Stone-Beck, Fell Foot, Newby Bridge (550), Lancs.

FOR SALE: New unused AR88D with matching speaker, trimming tools and manual, £85. Buyer collects.—Reynolds, 5 Headland Way, Lingfield, Surrey.

FOR SALE: Heathkit GR-54 five-band communications receiver, all usual refinements, newly factory aligned and tested, £45 or near offer.—Todd, Sundayshill Cottage, Falfield, Wotton-Under-Edge, Glos. GL12 8DQ.

SELLING: Heath HP-13A DC/PSU, £26. Calibrator 1000/100 kHz xtal, £3. Xtals, including types suitable for 2 and 4 metres, £1 each. Webster "Band-spanner", tunes 10 to 80 metres continuously on one coil, complete with Hustler heavy duty stainless-steel spring ball mount, new, £18. Hudson FM-208 on 2m., with microphone and manual, £18. R.216 receiver, coverage 19 to 157 MHz, FM/AM Rx, with new PSU, £48. K.W. 52-ohm dummy load, £4. T.W. 160m. Topmobile Rx, with spare case, £15. Valves QV08-100, with base, new, £8 each. Farnell type MSU stabilised DC/PSU, £5. G-whip, 160/80/20 metres, £9. 0-32v. DC/PSU, stabilised laboratory model, £18. Waters Clipreamp, £10. Various toroid transformers, valves, etc. Add postage. **WANTED:** Leica equipment.—Haycock, 178 Parkstreet Lane, Bricketwood, St. Albans, Herts. (Tel: Parkstreet 3638).

SALE: K.W. Vanguard Mk.II AM/CW Tx, £25. Buyer collects if possible.—North, G8IO, Grafton Manor, Bromsgrove (72151), Worcs.

FOR SALE: Two-metre Mosfet converter, IF 2.4 MHz, 4 by 4 by 1½ ins., £6. Two metre pre-amp., cascaded, 2N5245's, 2 by 1½ by 1½ ins., £3.—Ballance, G3KNB, QTHR, or ring Stafford 62105.

SELLING: RTTY Redifon ZA.39384/5 T.U., with manual and cables, £8. 7TR/3, £2. Peforator No. 44, £1. PSU 160v. DC, Auto/6S, aerial relays, 50p. Collect or carriage extra.—Coughlin, 34 Manor Rise, Walton, Stone, Staffordshire.

YUKAN SELF-SPRAY SO PROFESSIONAL THE YUKAN AEROSOL WAY—
Get these air drying GREY HAMMER BLACK WRINKLE NOW! OR (CRACKLE) finishes

Yukan Aerosol spraykit contains 453g. fine quality, durable easy instant spray. No stove baking required. Hammers available in grey and blue, 90p carr. pd. Modern Eggshell Black Wrinkle (Crackle) producing a 3D textured finish, 90p carr. pd., all at 85p per push-button self-spray can at our counter. Also durable, heat and water resistant Black Matt finish (339g. self-spray cans only) 75p carr. pd.

Other Yukan Air Drying Aerosols, 453g. at 90p carr. pd. include: Zinc Chromate Clear Lacquer Metallica: Grey, Blue.

SPECIAL OFFER: One can plus optional transferable snap-on trigger handle (value 25p) for 95p carr. pd. Choice of 13 self-spray plain colours and primer (motor car quality) also available.

Please enclose cheque or crossed P.O. for total amount direct to:
DEPT: SW J YUKAN, 3075, EDGWARE ROAD, LONDON W2 1BN
We supply many Government Departments, Municipal Authorities, Institutes and Leading Industrial Organisations—We can supply you too. *Now British—even better*

Open all day Saturday. Closed Thursday afternoons.



ELEY ELECTRONICS

150—S/H ½" computer tape rol 10½" in self-sealing plastic box—Good to cut-up for Recording Tape—35p plus 25p carriage.

300—Ex-G.P.O. 8 Bank Uniselectors—50p plus 25p carriage.

5,000—G.E.C. Circuit Boards 1" x 4"—each board has a minimum of 1 transistor or zener diode (with long leads) and associated components:
12 boards 10p plus 10p carriage.
50 boards 50p carriage free.
100 boards 95p carriage free.

Visit our surplus supermarket premises at 102 Bearice Road (off Fosse Road North). Nippiboard and Yaesu equipment now in stock.

112, GROBY ROAD, GLENFIELD, LEICESTER, LE3-8GL

HEAD MICROPHONE UNITS

FOR MOBILE OR FIXED STATION

Puts the microphone where it's needed and leaves hands free

Model C—Ceramic Unit and heat resistant at £4.95 post paid.

Model X—Crystal Unit at £4.60 post paid.

All Fully Selected
S.A.E. Details



'BOOMMIKE' P.O. Box 7, CHESTERFIELD, DERBYSHIRE

THE TRADING POST G8FET
7 CASTLE ST., HASTINGS, T. H. RANSOM
SUSSEX. TEL. HAS 4

| 2 METRE XTALS | | HC6/U | |
|---------------|-----------|------------|-----------|
| £1 inc. P.P. | | | |
| 24-025 MHz | = 144-150 | 24-172 MHz | = 145-056 |
| 24-038 " | = 144-228 | 24-182 " | = 145-092 |
| 24-041 " | = 144-246 | 24-198 " | = 145-188 |
| 24-058 " | = 144-348 | 24-205 " | = 145-230 |
| 24-070 " | = 144-420 | 24-212 " | = 145-272 |
| 24-085 " | = 144-510 | 24-220 " | = 145-320 |
| 24-110 " | = 144-660 | 24-232 " | = 145-392 |
| 24-125 " | = 144-750 | 24-245 " | = 145-470 |
| 24-135 " | = 144-810 | 24-258 " | = 145-548 |
| 24-142 " | = 144-852 | 24-268 " | = 145-608 |
| 24-150 " | = 144-900 | 24-278 " | = 145-688 |
| 24-162 " | = 144-972 | 24-288 " | = 145-728 |
| 24-166 " | = 144-996 | | |

SPECIAL OFFER: 1 MHz HC6/U @ 75p
XTALS CUT TO ANY FREQ. IN HC6/U
—HC18/U—HC25/U
PRICES ON APPLICATION

SENSIBLE Offers for: Western Union Deskfax. Class-D wavemeter. Ferrograph Series 5 and stereo amp. Type 1049 Mk.III 'scope. 1043 monitor. 1428 camera and drive unit, large quantity film. Type CT-54 VVM. Elliott 320 1 mA pen-recorder. Parts for 2/813 linear, including valves. Power supplies: 200v., 300v., 300 and 800v., 2/300v., elec. stabilised. Two UHF tuners. Two-metre converter. Two-metre 10-ele Yagi. Surplus rotor with control unit. 160-metre CW Tx. J36 bug key. Crystals: 500 kHz, 100 kHz, Chs. 48 and 49, 7060 kHz, 33-33 MHz. Quantity of meters, RSGB "Bulletins" 1963-70 complete. "Short Wave Magazine", Vols. 18-27 complete. "QST" 1970. Half-Cwt. relays, variable capacitors, transformers, etc.—Arnold, G3RHI, Summerfield Drive, Pestwich, Manchester (Tel: 061-773 2964).

SALE: Creed 'printer Type 7B, page, 28v., £10. Teleprinter 7B, tape, 250v., Rx only, no type, £5. T.U. Adap. Freq. Shift for above, ref. 10P/16142, £3 and PSU AP.66863, £3. PSU 90, 50plus-0-50minus, twice, £2. Tx/Rx SCR-522, 100-150 MHz, £6. Freq. meter LM.10 (BC-221), no charts or PSU, £8. BSR tape recorder, twin track 3-speed, needs attention, £5. Buyers collect.—Worthy, G3SNW, QTHR, or ring 01-644 1818 (South London).

MOBILE with the KW-2000A: DC/PSU, £25; Shure 201 microphone, £3. Both as new. (Bought FT-201).—Sharpe, G3UXU, QTHR (Herts).

FOR SALE: Pye Reporter (Low) and Pye Reporter (High), £3-00 the pair. G. & D. Mk.III two-metre converter, £3-00. National HRO-MX receiver, new S-meters (2), new dial assembly, seven coil packs 100 kHz to 30 MHz, working, but needs attention, £8-00. Receiver Type 78, £1-50. Commercial 80-0-80v. PSU for RTTY, £3-00. Marconi TF-1167 telegraph test generator (FSK simulator) in excellent condition, £8-00. Two Model 85R printing reperforators, would make one complete 85R, £8-00. One each Type RF Units 24, 26 and 27 (RF-27 on 4 metres), £2-50. All items carriage extra.—Poole, G8EPI, 5 River Drive, Strood, Rochester, Kent.

WANTED: by SWL, in mint condition, R.C.A. 8516L receiver. Please state details and price asked.—Nichol, 12 West View, Bedlington, Northumberland.

FOR SALE: Heathkit "Two'er" (HW-30), factory aligned, never used, with crystal, £22.—Abbott, 48 Cornhill Drive, Liversedge, Yorkshire, WF15, 7EF.

WANTED: T.W. two-metre "Communicator" and and TW-2 Tx with PSU/Control unit.—Box. No. 5074, Short Wave Magazine, Ltd., 55 Victoria Street, London, SW1H-0HF.

WANTED: T.W. two-metre "Communicator". Will not haggle.—Wheeler, G3RTW, QTHR, or ring Bromsgrove (Worcs.) 73313.

OFFERING: KW-2000A, with AC/PSU, Shure 201 mike, SWR bridge, low-pass filter and manual. HW-30, with two crystals, PA tuning, mike, 230v. transformer and handbook. Telemast, 40ft., with all rigging. Midland AM/VHF air-band receiver. All items in very good condition. Also a S/W Rx, needs attention. Offers, please?—Lockwood, G3XLL, 29 Coppice Avenue, Hellesdon, Norwich (48685), Norfolk.

FOR SALE: AR80 receiver (similar AR77E), covers 500 kHz to 27 MHz in 5 ranges, with bandspread, S-meter, BFO, xtal filter and modified RF section, £10. Buyer collects.—Harrison, G4AGW, ring 01-476 7092 (London).

SELLING: K.W. Vespa Mk.II, with PSU and Shure microphone, in immaculate condition and hardly used, £90. Deliver 30 mile radius of London.—Ring Harris, G3WHO, 01-739 0904.

SELLING: Teleton TF-182 FB, solid-state, mains/battery, LW/MW/Five SW bands, BFO, VHF, £48. Eddystone EC-10 Mk.I, with 924 power unit, £50. Trio 9R-59, with Eddystone plinth speaker, £25.—Radwell, 45 Stratton Road, Southampton, Hants.

FOR SALE: CT-52 miniature 'scope, working order, with manual and case, £15 or near offer.—James, 52 Leatherhead Road, Chessington, Surrey.

MORSE MADE !!!

FACT NOT FICTION. If you start RIGHT you will be reading amateur and commercial Morse within a month. (Normal progress to be expected.)

Using scientifically prepared 3-speed records you automatically learn to recognise the code RHYTHM without translating. You can't help it, it's as easy as learning a tune. 18-W.P.M. in 4 weeks guaranteed. For Complete Course 3 Records & Books send £4-50 (overseas £1 Extra).

For Further details of course Ring 01-660 2896/01-668 3255 or send 4 stamps for explanatory booklet to: G3HSC (Box 14) 45 GREEN LANE, PURLEY, SURREY.

TAURUS ELECTRICAL SERVICES

(Prop.: G3TED)

All prices include carriage

| | |
|---|--------------------|
| LIGHT HEADSETS | 75p |
| MINIATURE MORSE KEYS | 70p |
| 12PC. FOLDING AERIALS, NEW | 50p |
| SMALL FOLDING AERIALS | 30p |
| AIRCRAFT MACH METERS NEW | 80p |
| AIRCRAFT AIRSPEED SWITCHES, NEW | 70p |
| 10.8 Meg. XTAL FILTERS, small | £2-50 |
| MIXED XTALS. Our assortment, 10 for | £1-00 |
| ROLLER INDUCTORS, New | 75p |
| NEW VARIABLE CONDENSERS (BOXED). Spindle both ends, two types: | |
| 74PF + 74PF. 750v. D.C. (Polar type 015) | 75p |
| 102PF Single (Polar type 012) | 50p |
| MINIATURE ROTARY TRANSFORMERS. 28v. D.C. in 250v. D.C. at .06 out. Will run off 12v. giving approx. 150v. out. | 75p |
| 7-8K Heavy Duty W/W VARIABLE RESISTORS with knob. New, boxed | 50p |
| MIN. DIODE EQUIV. IN4007. 1,000 PIV at 1½ amps. | |
| NEW MODERN GEIGER COUNTERS 18p each or £2-00 doz. | |
| EPICYCLIC SLOW MOTION DRIVES. 8-1 ratio std. spindle | £6-50 |
| MAINS SMALL MOTORS. 1 REV/HR. Power full | 20p |
| SPECIAL OFFER OF QQV03-10's. Tested | 55p |
| New 6L6's. Tested | 55p |
| 6L6's. Ruggedised. New box 50 pds. Delivered | 80p |
| TELEPHONE HANDSETS | each |
| EX. G.P.O. TELEPHONES | £1-25 |
| E180CC valves | 25p |
| METERS: | |
| round 50-0-50 Microamp Meters | 80p |
| 2 1/2" Governed. 1 1/2" 400 | 35p |
| NEW 80 WATT POWER TRANSISTORS 2G221 | 30p |
| BY100's. Tested | 15p ea. £1-50 doz. |
| 144 Kc/s. TRANSCEIVERS. Less valves | £3-00 |
| With valves (15) | £5-00 |
| TRANS. CALL UNITS (mains intercoms). Complete with valves | £2-20 |
| RTTY | |
| CREED 7B's | |
| A1 Class 7B Teleprinters | £30-00 |
| A2 Average Condition 7B Teleprinters | £12-50 |
| Spare Governor | £3-00 |
| Spare 7-pin Plugs | 50p |
| Sprocket Paper O.K. for friction feed as well. Box of 10 pds. Delivered | £1-70 |
| Pink/yellow reperfr rolls. Box 20 pds. Delivered | £2-70 |
| Same price | £3-50 |
| Box 50 pds. Delivered | £5-00 |
| Delivered | £8-50 |
| CREED AUTO TXS (Tape Readers) | £8-50 |
| CREED 7TR Reperforators. Delivered | £18-00 |
| CREED 75R Printing Reperforators. Delivered | £8-50 |
| REGENERATIVE REPEATERS TRR2A | £130-00 |
| STC DRIVE EQUIPMENT TYPE 188 LRE58. 2-5 Megs. in cabinets | |
| MARCONI SSB DOUBLE DIVERSITY RECEIVERS HR24. 3-28 Megs. in 4 bands, type 4676. Complete equipment in 7ft. panel in good condition | £250-00 |
| MARGIN DISTORTION TEST SETS. In new condition with handbook, £7-50. Delivered. | |
| 26/28 NOTTINGHAM ROAD, LOUGHBOROUGH | |
| Telephone 5131 | |

P. & P. DEVELOPMENTS

Havant 72657
Shop Hours

GEC COURIERS. High or Low band fm personal R/T units. Up to 500 MW RF, double superhet receiver. These units are brand new and unused, complete with mike, earpiece and circuit diagram
£25 each or £42 pair carr. paid

STORNO BASE STATIONS. High band FM base stations complete with desk type control units, and connecting lead. The control unit has a built-in microphone and LS. units gives three switched channels, mute position, switched volume level. RT's are brand new and unused ... **£35 carr. paid**

HUDSON VHF FM BASE STATION. Complete low band TX/RX, ideal for converting to 4m. Good condition only ... **£27 carr. paid**

PYE VHF FM BASE STATION. QQV06-40A in the final. 16 selected channels. Complete with remote control unit and hand set. Very clean, only
£45 carr. paid

VHF FIBRE GLASS WHIP AERIALS. Ideal for cutting to 4-wave on 2m. ... **£1 carr. paid**

DRAKE T-4X AND MS-4 PSU. Perfect order and in really good condition, including top band.
Only **£175 carr. paid**

19 Lone Valley, WIDLEY, COSHAM, PORTSMOUTH, HANTS.

Cosham 74695
Evenings, Weekends

HIGH BAND AM BASE STATION. Runs QQV06-40A in final. Complete in cabinet only
£40 carr. paid

HIGH BAND AM MOBILES. BCC mobile units TX/RX with VIB PSU and microphone **£6 carr. paid**

LOW BAND PYE VANGUARD. Ideal for converting to 4m. Very good condition **£25 carr. paid**

MULLARD CERAMIC TRIMMERS. Type COOEA/6E, 0-6pF as used in many 2m. converters
20p each

UNMARKED TRIMMERS. 0-10pF, 5p each
For any special types please send S.A.E. for quote.

WE CAN NOW SUPPLY YAESU MUSEN AND K.W. EQUIPMENT. HP OR PERSONAL LOANS EASILY ARRANGED. S.A.E. FOR LISTS OF OTHER EQUIPMENT IN STOCK.

Terms of business Mail Order only CWO, min. order 25p. Viewing of equipment by appointment. Agent G8DOW, 20 Selhurst Way, Fair Oak, Eastleigh, Hants.

G3XKF

ALANDO

G3XKF

COMPRESSOR - AMPLIFIER

Add Gain and Punch to your signal.

5 transistor, P.P.3 Battery for instant operation as previously advertised. **£11.25 + 25p P. & P.**

MINITENNA COMMUNICATIONS
8 PEBBLEMOOR, EDLESBOROUGH,
DUNSTABLE, BEDS. (EATON BRAY 297)

QSL CARDS

Designed by specialists
Log Books — Reports, etc.

S.A.E. for samples:

NEW FOREST PRINTING CO. LTD.
31 Palfrey Place, Kennington, London, S.W.8.
Telephone 01-735 2020

KP4 on 70 cms !

Our 15-element yagi has received KP4 at RST 569 via the moon.
70 cms. multi grid reflector 15 ele. **£5.00** 10 ele. **£3.80** 7 ele. **£2.90**
2 metres ... 9 ele. **£3.45** 6 ele. **£2.80** 5 ele. **£2.25**
4 metres ... 6 ele. **£6.25** 5 ele. **£4.95** 3 ele. **£3.25**
All 75Ω feed, 2" dia. clamps provided and post paid. Ultra low loss coax 11p yd. 2" dia. galvanised masts, 10' **£2.20**, 16' **£3.30**, 20' **£4.40**. Couplers 95p. Full range TV aerials and fittings in stock, eg 14e VHF, **£2.35**.

JOHN R. R. BAKER
BONTNEWYDD, CARDS, SY23-4JH

THE RADIO SHOP

Dept. SWM, 16 Cherry Lane,
Bristol, BS1 3NG.

Tel.: Bristol 421196. STD Code 0272

Your West Country shop for electronic components and solid state devices

2 METRE CONVERTER KIT. 9V Neg. earth feeding 28-30 MHz. Consisting of: RF BF180, Fet. mixer, crystal osc. BF180, and multiplier BF180. Complete with all components, instructions and aluminium box.

Price **£4.75 P. & P. 18p.**

Catalogue 5p post free

TRIO?

THINKING OF BUYING A TRIO?

TS.510, JR.310, 9R-59-DS, etc. on demonstration. Send large s.a.e. for test report on JR.310 with Top Band, 144 MHz Con. use, Cal. unit, etc. Borrow a manual for 7 days. Deposit £2. Hire purchase, part exchange, Photo/Hi-Fi equipment etc.

HOLDINGS

39/41 MINCING LANE, BLACKBURN, BB2 2AF
Tel. 59595/6

2 METRE CONVERTERS

A.F.239 R.F. Stage. 2N5245 F.E.T. Mixer Xtal controlled Multiplier Chain. Size 4" x 3" x 1½". I.F.'s: 4-6, 18-20, 28-30 Mc/s. **£10.50 each.**

G. R. GRIGG, G3PRX
72 ELMSTONE ROAD, RAINHAM, KENT.
Telephone: Medway 361-433

To become a Direct Subscriber costs you (first-class posting) **£3.00 for a year of twelve issues, starting any time now. Orders to Circulation Dept., Short Wave Magazine, Ltd., 55 Victoria Street, London, SW1H-0HF**

"CALLBOOK"

With immediate effect—meaning the Winter editions of the U.S. and DX listings—the "Call Book" proper will be published only once a year, in December.

Supplements to both editions will appear at quarterly intervals, obtainable by prior order direct from the publishers.

We shall be able to supply the "Call Book" as an annual publication, as required at any time during the year, we shall not be handling the quarterly supplements. These will be available only direct from the publishers.

This comprehensive reference lists about 300,000 licensed radio amateurs in the United States Directory and 160,000 or more in the rest of the world (contained in the "DX Section"). In the U.S. Section, licence classifications are shown with revised listings of new licences, names and addresses. The CALLBOOK also includes much incidental DX information. Every amateur operator and SWL needs the CALLBOOK to get the most out of Amateur Radio.

DX Listings £3.10 US Listings £4.10

The two together, covering the World, £6.80

The above prices include postage and packing.

Your order to:

Publications Dept.,

SHORT WAVE MAGAZINE

55 Victoria Street, London, SW1H 0HF
01-222 5341

WORLD RADIO/TV HANDBOOK 1972

The World's only complete reference guide to International Radio & Television Broadcasting Stations. It includes: Frequencies, time schedules, announcements, personnel, slogans, interval signals and much more besides of value to the listener.

Lists all International short-wave stations, including frequencies, for each country; foreign broadcasts, long and medium wave stations (AM broadcast Band), TV stations and domestic programmes. Long recognised as the established authority by broadcasters and listeners. It is the only publication that enables you to identify BC stations quickly and easily. Enables you to fill more pages in your log book on the SW BC bands and helps you add more BC-station QSL cards to your collection.

£2.80

(The above price includes postage and packing).

from:

SHORT WAVE MAGAZINE
55 Victoria Street, London, SW1H 0HF

BERNARD BOOKS

| | |
|--|---------------|
| COIL DESIGN AND CONSTRUCTION MANUAL | 34p post paid |
| HANDBOOK OF TESTED TRANSISTOR CIRCUITS | 44p post paid |
| HOW TO MAKE AERIALS FOR T.V. (Band 1 & 3) AND V.H.F. (Band 2) | 22p post paid |
| HIGH FIDELITY LOUDSPEAKER ENCLOSURES | 22p post paid |
| RADIO & ELECTRONIC COLOUR CODES & DATA CHART | 20p post paid |
| RADIO TELEVISION AND ELECTRONICS DATA BOOK | 22p post paid |
| TRANSISTOR CIRCUITS MANUAL No. 1 | 20p post paid |
| HANDBOOK OF TRANSISTOR EQUIVALENTS & SUBSTITUTES | 44p post paid |
| HANDBOOK OF RADIO, T.V., & INDUSTRIAL TUBE & VALVE EQUIVALENTS | 44p post paid |
| WORLD'S SHORT WAVE MEDIUM & LONG WAVE RADIO STATIONS & FM & TV LISTING | 40p post paid |

Available from

SHORT WAVE MAGAZINE

Publications Dept., 55 Victoria Street,
London, SW1H 0HF 01-222 5341/2

(Counter Service, 9.30-5.15, Mon. to Fri.)

(Nearest Station: St. James's Park)

(GIRO A/c. No. 547 6151)

THE AMATEUR RADIO SHOP

G4MH

13 Chapel Hill, Huddersfield. Tel: 20774

| K.W. | Trio | Yaesu Musen |
|------------------|----------------------------|----------------|
| Atlanta ... £210 | TS510 ... £180 | FT101 ... £240 |
| 2000B ... £240 | JR599 ... £199 | FT200 ... £134 |
| 204 TX ... £145 | JR310 ... £84 | AC PSU ... £38 |
| 202 RX ... £140 | 9R59DS £47.50 | FT401 ... £215 |
| 107 ATU £40 | (Top Band available JR310) | |

| | | |
|-----------|-------------------------|--------|
| 2 Metres: | The 4MH 2 metre Tx. ... | £11.50 |
| | S.S.M. Converters ... | £13.75 |
| | S.S.M. Pre Amps ... | £6.50 |
| | 4MH 70 CM Converter ... | £7.80 |

J. Beams, xtals, etc.

Morse "Practice" Oscillator, 90p

SECOND-HAND

| | |
|--|------|
| Eddystone 830/7 (overhauled by Eddystone) | £230 |
| KW 2000B as new | £210 |
| Eddystone EA12. As new | £145 |
| Trio TS510. As new | £160 |
| AR88D + L/S, £45; 9R59DE, £32.50; 9R59DS, £38 | |
| Trio JR101, £28; BC221M + psu, £20; BC221, £15 | |

Wanted Rx's and Tx's

Carriage extra on all items. S.A.E. for any gen.
HP arranged. Full service facilities.

CLOSED TUESDAYS. LATE OPENING THURSDAYS
FREE CAR PARK